

Data Projector

Operating Instructions

Before operating the unit, please read this manual and supplied Quick Reference Manual thoroughly and retain it for future reference.

VPL-FHZ75/FHZ70

Not all models are available in all countries and area. Please check with your local Sony Authorized Dealer.



Table of Contents

Overview

Location and Function of Controls	4
Main Unit	4
Terminals	5
Remote Commander and Control Panel	6

Preparation

Connecting the Projector	8
Connecting a Computer	8
Connecting Video Equipment	9
Connecting an External Monitor and Audio Equipment	11
Connecting Network Equipment	12
Connecting to HDBaseT™ Equipment	13
Attaching the terminal cover	15

Projecting/Adjusting an Image

Projecting an Image	16
Adjusting the Focus, Size, and Position of the Projected Image	17
Correcting for Trapezoidal Distortion of the Projected Image (Keystone Adjustment)	18
Correcting Image Twist (Warp Correction Feature)	19
Blending Projections from Multiple Projectors on a Screen	21

Turning Off the Power	22
Using Convenient Functions	22
Enlarging a Part of the Image (Digital Zoom Function)	22
Projecting Images with Two Pictures Simultaneously (Two- Picture Display Function)	22
Setting the energy-saving mode (ECO mode)	23

Adjustments and Settings Using a Menu

Using a Menu	24
Projection Setting Menu	25
The Screen Menu	28
The Function Menu	31
The Operation Menu	32
The Connection/Power Menu	34
The Installation Menu	36
The Information Menu	40

Network

Using Network Features	41
Displaying the Control Window of the Projector with a Web Browser	41
Confirming the Settings for the Projector	42
Operating the Projector from a Computer	42
Using the e-mail Report Function	43
Configure the Network Settings	45

Setting the Control Protocol of
the Projector 46

Others

Indicators 49
Messages List 51
Troubleshooting 52
Cleaning the Air Filter 55
Replacing the Projection Lens 56
 Removing 56
 Attaching 57
Specifications 58
Projection Distance and Lens Shift
 Range 65
Dimensions 68
About Trademarks 69

Location and Function of Controls

Main Unit

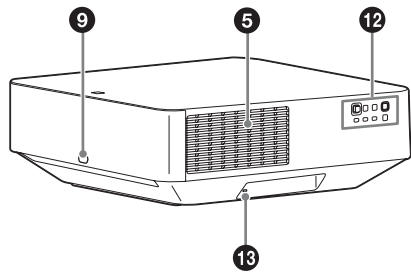
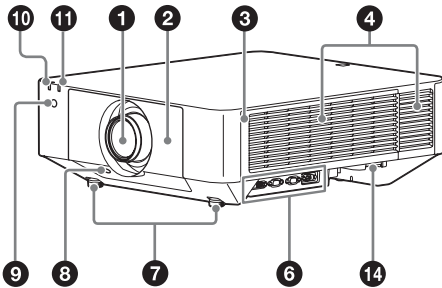

1 Lens (page 56)

2 Front panel

3 Side cover (page 55)

4 Ventilation holes (intake)

5 Ventilation holes (exhaust)

Caution

Do not place anything near the ventilation holes as this may cause internal heat buildup. Do not place your hand near the ventilation holes (exhaust) and the circumference as this may cause injury.

6 Terminals (page 5)

7 Front feet (adjustable) (page 18)

8 LENS RELEASE button (page 56)

9 Remote control receiver

The remote control receivers are located at the front and rear of the projector.

10 ON/STANDBY indicator (page 49)

11 WARNING indicator (page 49)

12 Control panel (page 6)

13 Antitheft lock

Connects to an optional antitheft cable manufactured by Kensington. For details, visit the Kensington's web site.
<http://www.kensington.com/>

14 Antitheft bar

Connects to a commercially available antitheft chain or wire.

Terminals

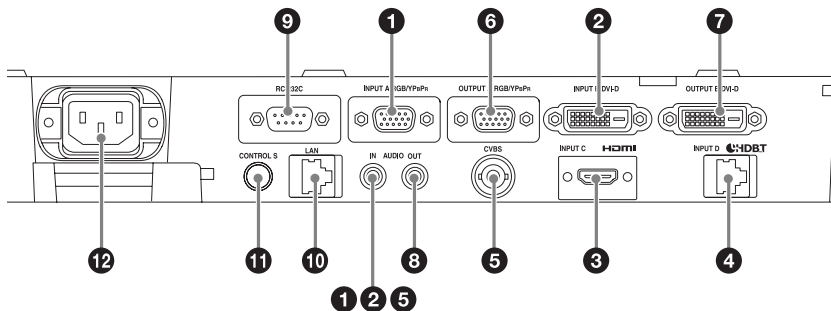

Input (page 8)

1 INPUT A

Video: RGB/YP_BPr input terminal (RGB/YP_BPr)

Audio: Audio input terminal (AUDIO)

2 INPUT B

Video: DVI-D input terminal (DVI-D)

Audio: Audio input terminal (AUDIO)

3 INPUT C

Video: HDMI input terminal (HDMI)

Audio: HDMI input terminal (HDMI)

4 INPUT D

HDBaseT terminal

5 VIDEO (VIDEO IN)

Video: Video input terminal

Audio: Audio input terminal (AUDIO)

Notes

- The audio input terminals of the projector are for output to external equipment. Connect external audio equipment to output audio (page 11).
- The audio inputs of INPUT A, INPUT B, and VIDEO are shared.

Output (page 11)

6 OUTPUT A

Video: RGB/YP_BPr output terminal (RGB/YP_BPr)

7 OUTPUT B

Video: DVI-D output terminal (DVI-D)

8 AUDIO OUT

Audio: Audio output terminal (AUDIO)

Note

These terminals output projected images or audio. As for images, the signal input from INPUT A is output from OUTPUT A, and the signal input from INPUT B is output from OUTPUT B. However, if the signal input from INPUT B is protected by HDCP, the signal is not output from OUTPUT B. As for audio, when INPUT A or B, or VIDEO is selected, the audio signal input from the audio input terminal is output; when INPUT C or D is selected, the audio signal input from the selected input terminal is output.

Others

9 RS-232C terminal

RS-232C compatible control terminal

10 LAN terminal (page 12)

11 CONTROL S input terminal (DC power supply) (CONTROL S)

Connects to the CONTROL S output terminal on the supplied Remote Commander with a connecting cable (stereo mini plug (not supplied)) when using it as a wired Remote Commander. You do not need to install batteries in the Remote Commander, as the power is supplied from this terminal.

12 AC IN (~) socket

Connects the supplied AC power cord.

Remote Commander and Control Panel

Remote Commander

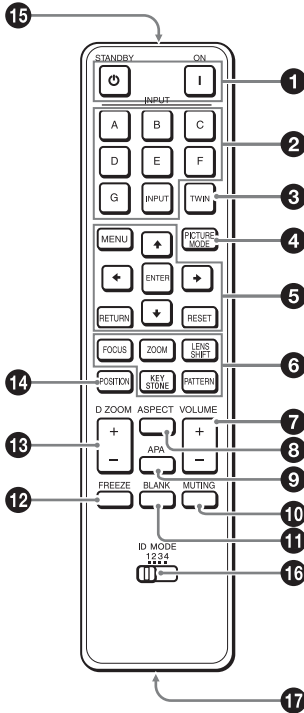

Control Panel

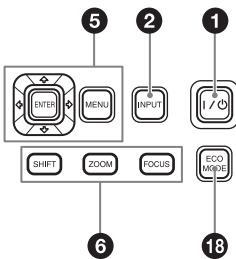

1 I (On) key / Standby key

Turns on the projector or enters the standby mode.

2 INPUT key / Direct input select keys

Select an input signal (page 16).

Select the VIDEO (VIDEO IN) signal with the INPUT key.

The E, F, and G keys are not used with this projector.

3 TWIN (Twin Picture) key

Simultaneously projects images from two input signals on the screen as a main picture and subpicture (page 22).

4 PICTURE MODE key

Switches the “Picture Mode” setting (page 25).

Note

When “Intelligent Setting” in the Projection Setting menu is set to “On,” “Picture Mode” cannot be set (page 25).

5 MENU key / ENTER key / Arrow keys / RETURN key / RESET key

Used for menu operation (page 24).

6 FOCUS key

Used when the electric focus lens is attached (page 17).

ZOOM key

Used when the electric zoom lens is attached (page 17).

LENS SHIFT / SHIFT key (page 17) / PATTERN key (page 18) / KEYSTONE key (page 18)

Used for adjusting the projected image.

7 VOLUME key

Adjusts the volume output from the audio output terminal of the projector.

8 ASPECT key

Changes the aspect ratio of the projected image (page 30).

9 APA (Auto Pixel Alignment) key

Automatically adjusts a picture to its clearest while a signal from a computer is input via the RGB input terminal (INPUT A). You can cancel the adjustment by pressing the APA key again while adjusting.

10 MUTING key

Mutes the audio output. Press again to restore the previous volume.

11 BLANK key

Temporarily cuts off the image. Press again to restore the image.

12 FREEZE key

Pauses a projected image. Press again to restore the image. Use this key when inputting a computer signal.

13 D ZOOM (Digital Zoom) key

Enlarges a part of the image while projecting (page 22).

14 POSITION (Picture Position) key

Not in use for the projector.

15 Infrared transmitter

16 ID MODE switch (page 32)

Set an ID mode of the Remote Commander. If you assign a different ID number to each projector when multiple projectors are used, you can control only the projector with the same ID mode as that of the Remote Commander.

17 CONTROL S output terminal

Connect to the CONTROL S input terminal on the projector with a connecting cable (stereo mini plug (not supplied)) to use the Remote Commander as a wired one.

You do not need to install batteries in the Remote Commander, as the power is supplied from the projector.

18 ECO MODE key

Used for energy-saving mode setting (page 23).

- If there is any obstruction between the Remote Commander and the remote control receiver on the projector, the projector may not be able to receive signals from the Remote Commander.

About Remote Commander operation

- Direct the Remote Commander toward the remote control receiver.
- The shorter the distance between the Remote Commander and the projector is, the wider the angle within which the Remote Commander can control the projector becomes.

Connecting the Projector

Notes

- Turn off all equipment before making any connections.
- Use the proper cables for each connection.
- Insert the cable plugs firmly; Loose connections may reduce performance of picture signals or cause a malfunction. When pulling out a cable, be sure to grip it by the plug, not the cable itself.
- For more information, refer also to the instruction manuals of the equipment you are connecting.
- Use a no-resistance audio cable.

Connecting a Computer

Connection with a computer is explained for each input signal.

INPUT A

For connecting a computer with an RGB output terminal.

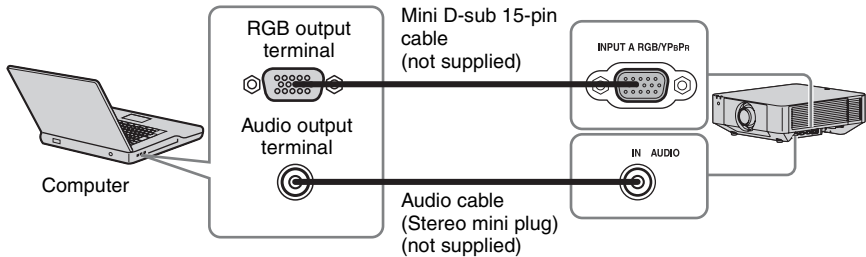

Note

It is recommended that you set the resolution of your computer to 1920 × 1200 pixels for the external monitor.

INPUT B

For connecting a computer with a DVI-D output terminal.

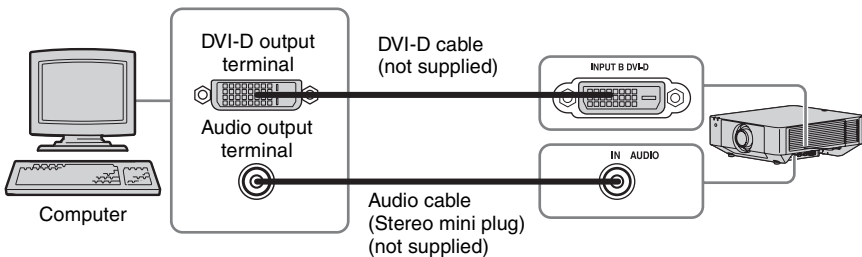

INPUT C

For connecting a computer with an HDMI output terminal.

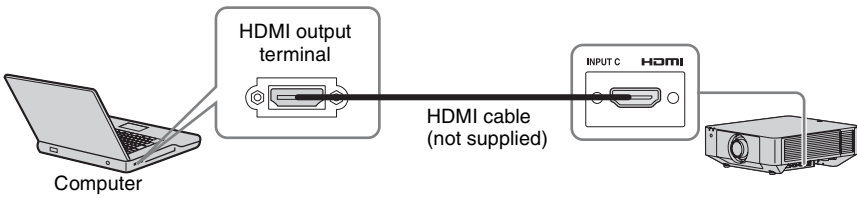

Notes

- Use HDMI-compatible equipment which has the HDMI Logo.
- Use a high speed HDMI cable(s) on which the cable type logo is specified. (Sony products are recommended.)
- The HDMI terminal of this projector is not compatible with DSD (Direct Stream Digital) signal or CEC (Consumer Electronics Control) signal.

Connecting Video Equipment

Connections with a VHS videocassette recorder, DVD player, or BD player are explained for each input signal.

VIDEO IN

For connecting video equipment with a video output terminal.

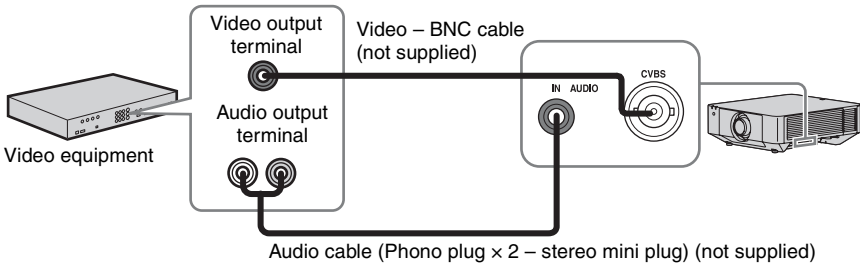

INPUT A

For connecting video equipment with a YPbPr output terminal.

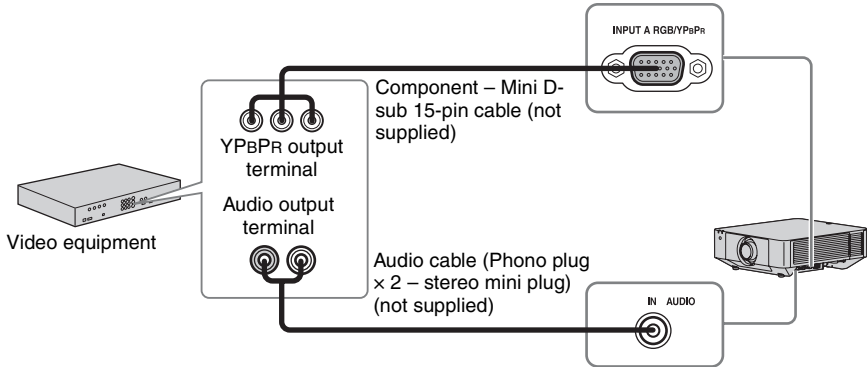

INPUT C

For connecting video equipment with an HDMI output terminal.

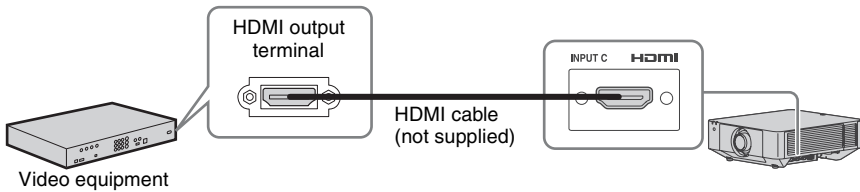

Notes

- Use HDMI-compatible equipment which has the HDMI Logo.
- Use a high speed HDMI cable(s) on which the cable type logo is specified. (Sony products are recommended.)
- The HDMI terminal of this projector is not compatible with DSD (Direct Stream Digital) signal or CEC (Consumer Electronics Control) signal.

To fix the HDMI cable

Fix the cable to the cable tie holders at the sides of the terminals using a commercially available cable tie, as shown in the illustration.

Use a cable tie of less than 1.9 mm × 3.8 mm in thickness.

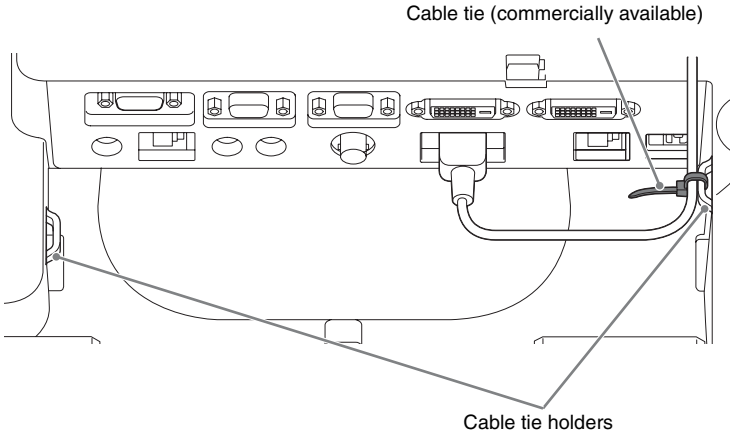

Connecting an External Monitor and Audio Equipment

Projected images and input audio can be output to display equipment such as a monitor and audio equipment such as speakers with a built-in amplifier.

OUTPUT A

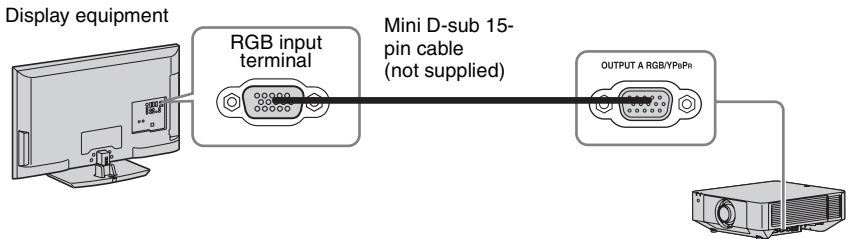

Note

This terminal outputs projected images. The images are output when a computer signal or video signal is input from the RGB/YpPr input terminal (INPUT A).

OUTPUT B

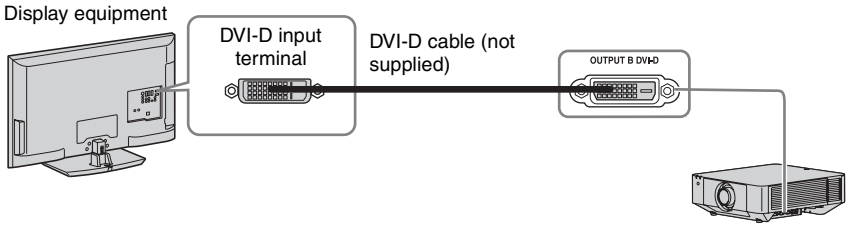

Note

This terminal outputs projected images. The images are output when a computer signal is input from the DVI-D input terminal (INPUT B). However, if the signal input from INPUT B is protected by HDCP, the signal is not output to OUTPUT B.

AUDIO output

When INPUT A or B, or VIDEO is selected, the audio input from the audio input terminal is output; when INPUT C or D is selected, the audio input from the selected input terminal is output.

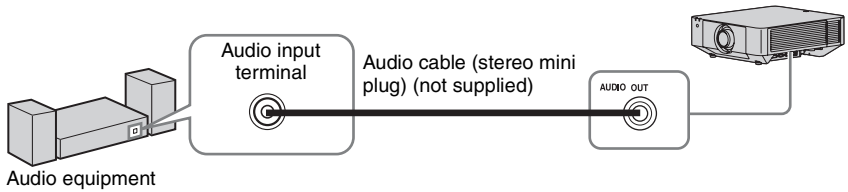

Connecting Network Equipment

Connecting network equipment

LAN terminal

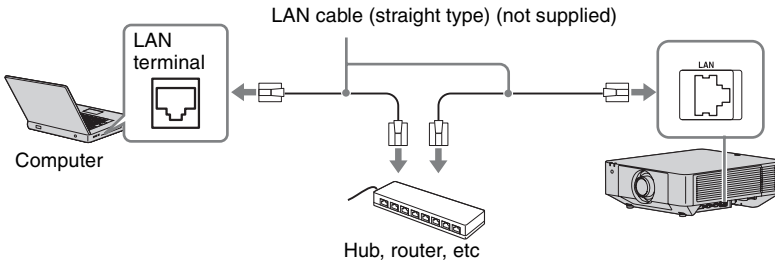

Note

When using network features via the LAN terminal, be sure to check if "LAN Setting" is set to "LAN Port" (page 34).

Connecting to HDBaseT™ Equipment

For connecting the computer, video equipment, and network equipment via the HDBaseT transmitter.

Connecting to the computer

INPUT D

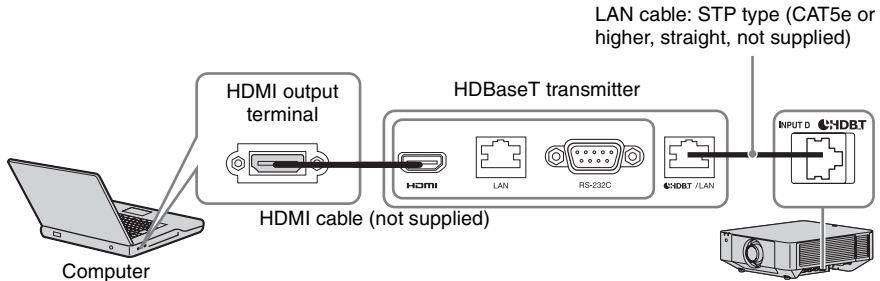

Connecting to video equipment

INPUT D

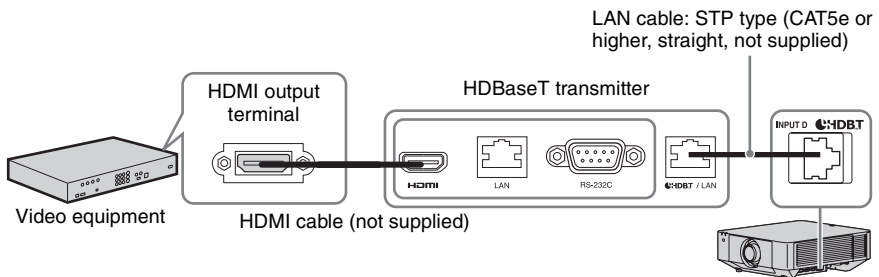

Notes for connecting this unit and the HDBaseT transmitter

- Ask a professional or Sony dealer to perform wiring. If wiring is not correct, the transmission characteristics of the cable will not be achieved, and image or sound may break up or you may experience unstable performance.
- Connect the cable directly to the HDBaseT transmitter without going through a hub or router.
- Use cables that meet the following conditions.
 - CAT5e or higher
 - Shielded type (covering connectors)
 - Straight wire connection
 - Single wire
- When installing the cables, use a cable tester, cable analyzer, or similar device to check if the cables meet the CAT5e or higher requirement. If there is a transit connector between this unit and the HDBaseT transmitter, include it when measuring.
- To reduce the affect of noise, install and use the cable in a manner where it is not rolled up and it is as straight as possible.
- Install the cable away from the other cables (especially the power cable).
- When installing multiple cables, do not bind them and keep the running parallel distance as short as possible.

- The transmittable distance of the cable is 100 m (approx. 328 feet) maximum. If it exceeds 100 m (approx. 328 feet), it may cause the image or the sound to break up, or cause a malfunction in LAN communication. Do not use the HDBaseT transmitter beyond the transmittable distance.
- Inquire about operation or function problems caused by other manufacturer's devices with the relevant manufacturer.

Connecting to network equipment

For connecting to network equipment via the HDBaseT terminal to control the projector.

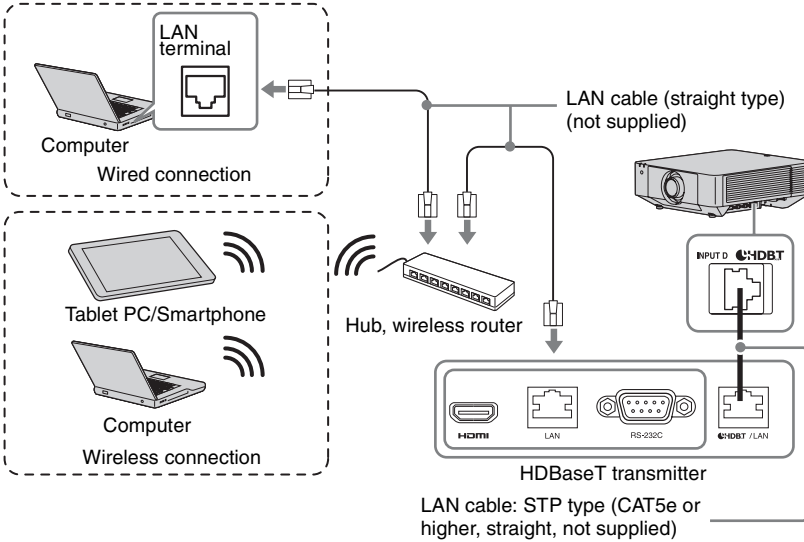

Notes

- When using network features, be sure to check if “LAN Setting” is set to “via HDBaseT” (page 34).
- Connect this unit and the HDBaseT transmitter directly without a hub or router.
- Set “Extron XTP” in the Connection/Power menu to “On” when connecting to XTP Systems manufactured by Extron Electronics (page 34).

Attaching the terminal cover

You can attach the supplied terminal cover to prevent dust from entering the terminals to maintain a neat appearance.

- 1 Fit one shaft on the side of the terminal cover into the hole on the bottom, then fit the other shaft by bending the cover slightly.

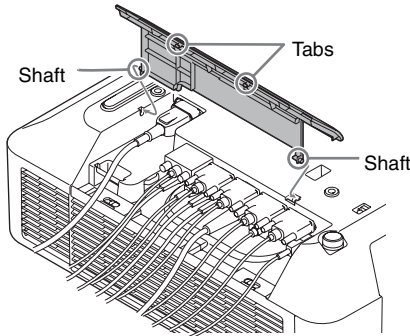

- 2 Close the terminal cover.
Close the terminal cover until the two tabs on the terminal cover click.

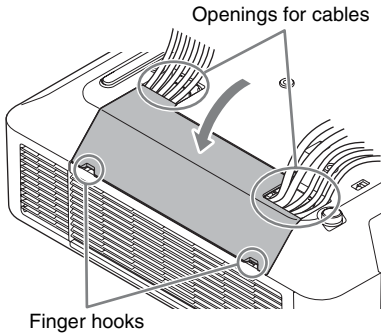

Example of the cable layout in the cover

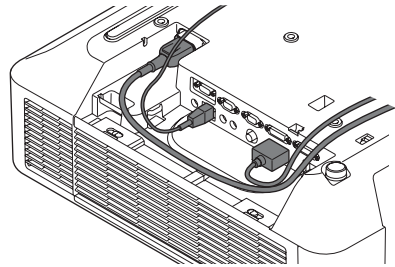

Note

The terminal cover may not be attached depending on the installation method, such as due to the condition of the connected cables or when installing the unit on the floor. However, this has no impact on normal use.

Opening the terminal cover

Raise the cover by inserting your fingers into the finger hooks.

Projecting an Image

The size of a projected image depends on the distance between the projector and screen. Install the projector so that the projected image fits the screen size. For details on projection distances and projected image sizes, see “Projection Distance and Lens Shift Range” (page 65).

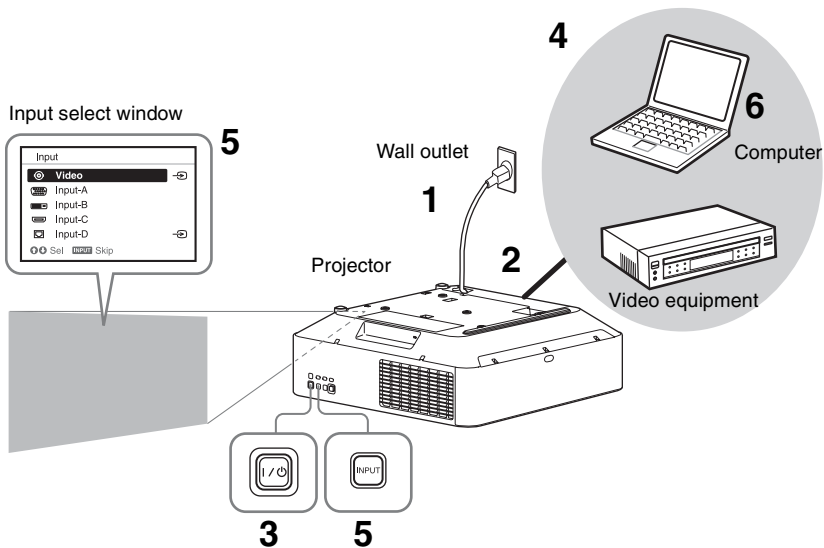

- 1** Plug the AC power cord into a wall outlet.
- 2** Connect all equipment to the projector (page 8).
- 3** Turn on the projector.
Press the I/⏻ key on the main unit or the I key on the Remote Commander.
- 4** Turn on the connected equipment.
- 5** Select the input source.
Press the INPUT key on the projector to display the input select window. Press the INPUT key repeatedly or the ⬆/⬇ key to select an image to be projected. The signal icon -Ⓢ appears on the right side in the input select window when a signal is input.

You can select the input source using Direct input select keys on the Remote Commander (page 6).



- 6** Switch your computer to output to external display by changing your computer's setting.
How to switch the computer to output to the projector varies, depending on the type of computer.

(Example)

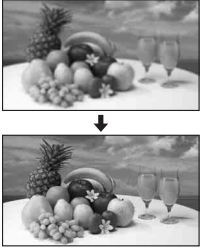

- 7** Adjust the focus, size, and position of the projected image (page 17).

Adjusting the Focus, Size, and Position of the Projected Image

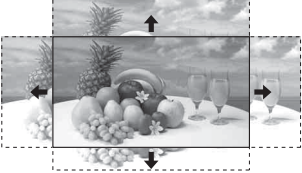
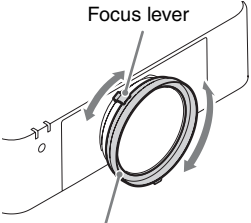
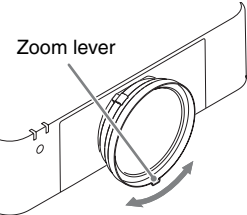
Focus	Size (Zoom)	Position (Lens shift)
		
<p>When attaching the Electric focus lens Press the FOCUS key on the projector or the Remote Commander then press the ▲/▼/◀/▶ key to adjust the focus.</p> <p>When attaching the Manual focus lens Turn the focus lever and peripheral focus ring to adjust the focus. You can adjust the focus of the peripheral area by rotating the peripheral focus ring.</p> <div style="text-align: center;">  <p style="text-align: center;">Focus lever</p> <p style="text-align: center;">Peripheral focus ring</p> </div>	<p>When attaching the Electric zoom lens Press the ZOOM key on the projector or the Remote Commander then press the ▲/▼/◀/▶ key to adjust the size.</p> <p>When attaching the Manual zoom lens Turn the zoom lever to adjust the size.</p> <div style="text-align: center;">  <p style="text-align: center;">Zoom lever</p> </div>	<p>Press the LENS SHIFT/SHIFT key on the projector or the Remote Commander then press the ▲/▼/◀/▶ key to adjust the position.</p> <p>To return the lens to the center position of the projected image Press the RESET key on the Remote Commander while adjusting.</p>

Adjusting the tilt of the projector with the front feet (adjustable)

When the projector is installed on an uneven surface, you can adjust using the front feet (adjustable).

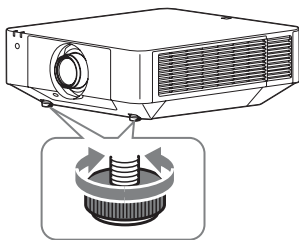

Notes

- Be careful not to let the projector down on your fingers.
- Do not push hard on the top of the projector with the front feet (adjustable) extended. It may cause a malfunction.

Displaying a pattern for adjusting an image

You can display a pattern for adjusting the projected image with the PATTERN key on the Remote Commander. Use $\blacktriangle/\blacktriangledown$ to change the pattern and $\blacktriangleleft/\blacktriangleright$ to change its color. Press the PATTERN key again to restore the previous image.

Correcting for Trapezoidal Distortion of the Projected Image (Keystone Adjustment)

If the screen is tilted, or you are projecting from an oblique angle, perform keystone adjustment.

If the projected image is trapezoidally-distorted in the vertical plane

- 1 Press the KEYSTONE key on the Remote Commander once or select “Screen Fitting” in the Installation menu (page 36).
The “Screen Fitting” menu is displayed.
- 2 Select “V Keystone.”

- 3 Adjust the value using $\blacktriangleleft/\blacktriangleright$.
The higher the setting, the narrower the top of the projected image. The lower the setting, the narrower the bottom of the projected image.

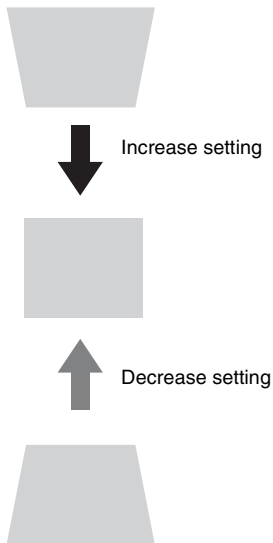

Press the RESET key to restore the projected image before adjustment.*1

If the projected image is trapezoidally-distorted in the lateral plane

- 1 Press the KEYSTONE key on the Remote Commander once or select “Screen Fitting” in the Installation menu (page 36).
The “Screen Fitting” menu is displayed.
- 2 Select “H Keystone.”

- 3** Adjust the value using \leftarrow/\rightarrow .
The higher the setting, the narrower the right side of the projected image. The lower the setting, the narrower the left side of the projected image.

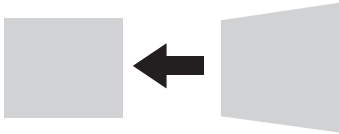

Increase the setting

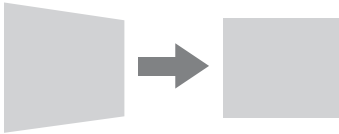

Decrease setting

Press the RESET key to restore the projected image before adjustment.*1

Notes

- *1: The setting may not be reset depending on the combination of adjustment values of the Screen Fitting setting items. In this case, reset all of the Screen Fitting setting items.
- Keystone adjustment is an electronic correction. Consequently the image quality may deteriorate.
 - Depending on the position adjusted with the lens shift feature, using the Keystone feature may change the aspect ratio of the original image, or the projected image may be distorted.

Correcting Image Twist (Warp Correction Feature)

You can correct image twist with the warp correction feature.

- 1** Press the KEYSTONE key on the Remote Commander once or select “Screen Fitting” in the Installation menu (page 36).
The “Screen Fitting” menu is displayed.

- 2** Select “Warping.”
The guide is displayed.

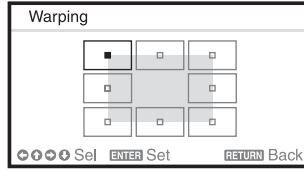

When correcting the corner(s) of the image

- 1** Move \blacksquare using $\uparrow/\downarrow/\leftarrow/\rightarrow$ to select the corner you want to correct.

- 2** Press the ENTER key.
The cursor appears.

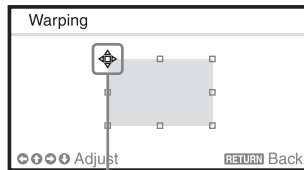

Adjust using this cursor

- 3** Adjust the position of the corner you want to correct, using $\uparrow/\downarrow/\leftarrow/\rightarrow$.

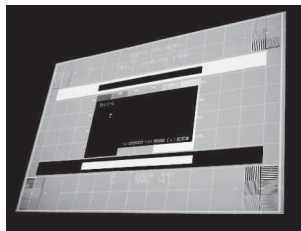

Press the RESET key to restore the projected image before adjustment.*1

When correcting deflection on the left/right sides of the image

- 1 Move ■ using ▲/▼/◀/▶ to select the side you want to correct.

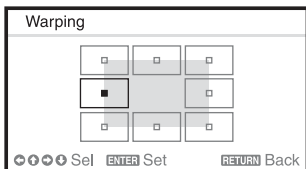

- 2 Press the ENTER key. The cursor appears.

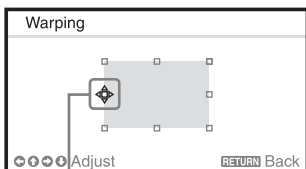

Adjust using this cursor

- 3 Adjust the deflection of the side, using ▲/▼/◀/▶.

You can adjust the center point of deflection using ▲/▼. For the range of deflection, use ◀/▶. You can adjust the left/right side independently.



Press the RESET key to restore the projected image before adjustment.*1

When correcting deflection on the top/bottom sides of the image

- 1 Move ■ using ▲/▼/◀/▶ to select the side you want to correct.

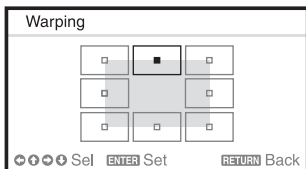

- 2 Press the ENTER key. The cursor appears.

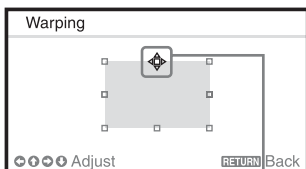

Adjust using this cursor

- 3 Adjust the deflection of the side, using ▲/▼/◀/▶.

You can adjust the center point of deflection using ▲/▼. For the range of deflection, use ◀/▶. You can adjust the top/bottom independently.

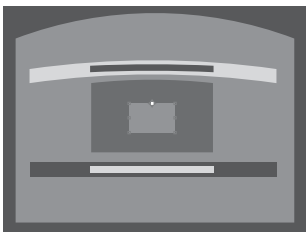
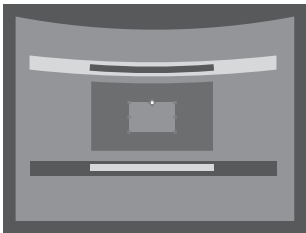

Press the RESET key to restore the projected image before adjustment.*1

Note

*1: The setting may not be reset depending on the combination of adjustment values of the Screen Fitting setting items. In this case, reset all of the Screen Fitting setting items.

Blending Projections from Multiple Projectors on a Screen

- 1 Install the projectors.
Input a pattern, etc., to adjust the projected positions from multiple projectors.
- 2 Set the ID mode.
Set a different ID mode for each projector (page 32).
- 3 Set the picture mode.
Set the picture mode of the multiple projectors to “Multi Screen” (page 25).
- 4 Unify the color space.
Set the color space of the multiple projectors to the same mode (Custom 1 to 3) (page 36). R/G/B can be finely adjusted as necessary.
- 5 Adjust the color matching setting.
Finely adjust each tone as necessary (page 36).
- 6 Set the Edge Blending setting.
When overlaying multiple projections, the Edge Blending setting is available. Select “Multi Screen” in the Installation menu, then select “Edge Blending” (page 36).
- 7 Enable the Edge Blending function.
In “Blend Settings,” set “Edge Blending” to “On” for each blending position.

8 Set the blending width.

Set the blending width according to the overlapping range for the source signal.

Assign the width here.

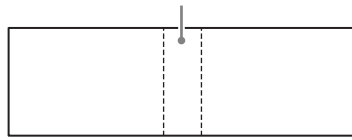

9 Adjust using “Blend Fitting.”

Finely adjust the overlapped area.

10 Adjust using “Zone Black Level Adj.”

Adjust each correction zone by “Zone Black Level Adj.” for the most uniform black level between each zone. During this adjustment, a black image is automatically projected.

Notes

- Depending on the blending start position or the blending width, the menu may overlap with the blending area and become invisible. If you want to operate the projector while viewing the menu, set “Edge Blending” to “Off” once and make adjustments. Then, set “Edge Blending” to “On.”
- The procedure shown above is for general guidance. Your own installation may vary according to the situation.
- When multiple projectors are set up in a line, the temperature inside the projectors may increase due to exhaust vent proximity, and an error indication may result. In this case, space the projectors farther apart and/or install deflection partitioning between them. For more details, consult with qualified Sony personnel.

Turning Off the Power

- 1 Press the I/⏻ key on the main unit or the ⏻ key on the Remote Commander. The projector starts shutdown and turns off.
- 2 Unplug the AC power cord from the wall outlet.

Using Convenient Functions

Enlarging a Part of the Image (Digital Zoom Function)

Enlarges a portion of the image while projecting. Use this key when inputting a computer signal. But it may not be enabled, depending on the resolution of the input signal and when displaying two pictures.

- 1 Press the D ZOOM + key to display the digital zoom icon on the projected image.
- 2 Press the ↑/↓/←/→ keys to move the digital zoom icon to the point on the image you wish to enlarge.
- 3 Press the D ZOOM + key or the D ZOOM – key repeatedly to change the enlargement ratio.

The image can be enlarged up to 4 times. Press the RESET key to restore the previous image.

Projecting Images with Two Pictures Simultaneously (Two-Picture Display Function)

You can project the images from two input signals on the screen as a main picture and subpicture at the same time. To switch between one and two pictures, press the TWIN key.

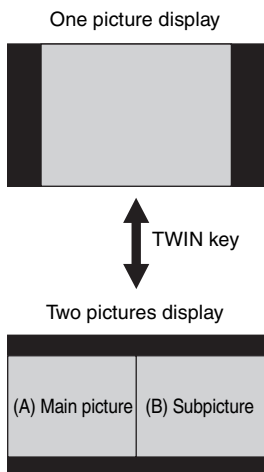



You can select the image to project to the main picture.

The subpicture is preset to source the signal input from INPUT A. INPUT A is only compatible with signals from computers.

Combinations of input signals

Main picture	Subpicture
INPUT B (DVI-D)	INPUT A (RGB)
INPUT C (HDMI)	
INPUT D (HDBaseT)	

Notes

- When “Screen Aspect” (page 37) is set to “4:3,” the two picture function is not available.
- When displaying two pictures, the input signal icon  does not appear in the input select window (page 16).
- Picture settings set for one picture may not be reflected as two pictures.
- When displaying two pictures, the I (On) key,  (standby) key, INPUT key, and BLANK key are available.

Setting the energy-saving mode (ECO mode)

Energy-saving mode can be set easily. Energy-saving mode consists of “With No Input,” “With Static Signal” and “Standby Mode.”

- 1 Press the ECO MODE key to display the ECO Mode menu.

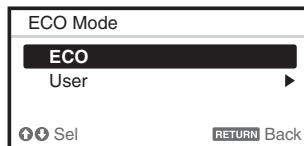

- 2 Press the  key or ECO MODE key to select “ECO” or “User” mode.

ECO: Sets each mode to the optimum energy-saving value.

-With No Input: Standby

-With Static Signal: Light Dimming

-Standby Mode: Low

User: Sets each item of the energy-saving mode menu as you desire.

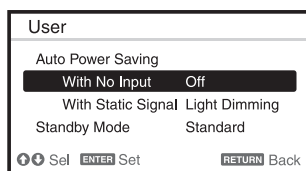

- 3 Press the RETURN key to restore the previous image.

For details on ECO Mode settings, see “With No Input,” “With Static Signal,” and “Standby Mode” on the Connection/Power menu (page 34).

Note

If you set “ECO Mode” to “ECO,” or “Standby Mode” (in “User”) to “Low,” the network control function will be disabled in standby mode. If the external control is being performed by using the network or network control function, do not select “ECO,” or do not set “Standby Mode” (in “User”) to “Low.”

Using a Menu

Note

The menu displays used for the explanation below may be different depending on the model you are using.

1 Press the MENU key to display the menu.

2 Select the setting menu.

Use the \uparrow or \downarrow key to select the setting menu, then press \rightarrow or ENTER key.

Setting menu

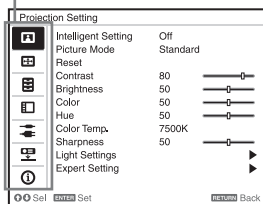

3 Select the setting item.

Use the \uparrow or \downarrow key to select the setting menu, then press \rightarrow or ENTER key.

To return to the selection screen of the setting menu, press the \leftarrow key or the RETURN key.

Setting items

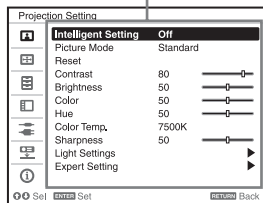

4 Make the setting or adjustment for the selected item.

Menu operation differs depending on the setting item. If the next menu window is displayed, select the item according to the operations in step 3 and then press the ENTER key to register the setting.

To return to the selection screen of the setting items, press the \leftarrow key or the RETURN key. Also, to reset the setting value of an item to its factory preset value, press the RESET key during setting or adjusting.

Using a pop-up menu

Press the $\uparrow/\downarrow/\leftarrow/\rightarrow$ key to select an item. Press the ENTER key to register the setting. The previous screen is restored.

Selecting items

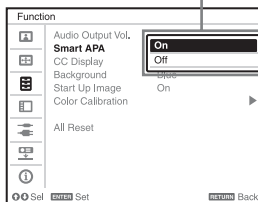

Using the setting menu

Press the \uparrow or \downarrow key to select the item.

Press the ENTER key to register the setting. The previous screen is restored.

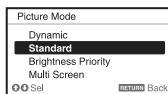

Using the adjustment menu

To increase the number, press the \uparrow or \rightarrow key and to decrease the number, press the \downarrow or \leftarrow key. Press the ENTER key to register the setting. The previous screen is restored.



5 Press the MENU key to clear the menu.

The menu disappears automatically if no key is pressed for a while.

Projection Setting Menu

The Projection Setting menu is used for optimum settings appropriate to the installation location and picture adjustments for input signals.

Setting items	Description
Intelligent Setting	<p>On/Off: When you set to “On,” you can optimize the picture settings, light settings, and system cooling performance (fan rotation speed) by selecting the installation location from “Location” according to the environment in which the projector is used. This setting is for stable and prolonged use of the projector. *¹</p> <p>Location *²: Select usage location of the projector from the following options.</p> <p>Meeting/Class Room: Sharply projects text and graphics. This is suitable for use in meeting rooms or classrooms.</p> <p>Museum: Precisely reproduces colors. This is suitable for use in quiet places, such as galleries or museums.</p> <p>Entertainment: Produces well-contrasted pictures. This is suitable for use in theme parks or public entertainment facilities.</p> <p>Multi Screen: This is suitable when simultaneously using multiple projectors for projections, such as blending projections or projections from multiple projectors set up side-by-side.</p>
Picture Mode * ¹	<p>Dynamic: Emphasizes the contrast to produce a “dynamic” picture.</p> <p>Standard: Makes the picture be natural and well balanced.</p> <p>Brightness Priority: Makes the picture bright to suit a bright environment.</p> <p>Multi Screen: Optimizes the picture quality to suit projecting using multiple projectors.</p>
Reset	<p>The picture settings are initialized to their factory preset values. However, “Intelligent Setting,” “Picture Mode,” and “Color Temp.” (“Custom 1,” “Custom 2,” “Custom 3,” and “Custom 4”) do not return to the factory preset values.</p>
Contrast	<p>The higher the setting, the greater the contrast. The lower the setting, the lower the contrast.</p>
Brightness	<p>The higher the setting, the brighter the picture. The lower the setting, the darker the picture.</p>
Color	<p>The higher the setting, the greater the intensity. The lower the setting, the lower the intensity.</p>
Hue	<p>The higher the setting, the more greenish the picture becomes. The lower the setting, the more reddish the picture becomes.</p>
Color Temp.	<p>9300K/7500K/6500K: The higher the temperature, the more bluish the picture. The lower the temperature, the more reddish the picture.</p> <p>Brightness Priority: Projects images at the maximum brightness.</p> <p>Custom 1/ Custom 2/ Custom 3/ Custom 4: An adjusted color temperature setting can be stored for each item.</p> <p>The factory settings are Custom 1: 9300K, Custom 2: 7500K, Custom 3: 6500K, Custom 4: Brightness Priority.</p>
Sharpness	<p>The higher the setting, the sharper the picture. The lower the setting, the softer the picture.</p>

Setting items	Description
Light Settings* ¹	
Dynamic Control	On/Off: Brightness is adjusted automatically according to image content. Dark images are projected with brightness adjusted, leading to energy-saving. Bright images are projected brightly, without adjusting brightness.
Light Output Mode	Adjusts brightness of the light source. Standard: The image becomes brighter, and power consumption becomes higher. Middle: Power consumption becomes lower; however, the image will be darker. Extended: The images becomes dark but extended projection is enabled. Custom: You can adjust brightness as prefer.
Constant Brightness* ₃	On/Off: Available when Light Output Mode is set to “Standard” or “Middle.” Brightness is constant at about 80% of light output of each mode.
Expert Setting	
Reality Creation	Adjusts the detail and noise processing of images. (Super-resolution function) On: Adjusts the settings of “Reality Creation.” Resolution: When you increase the setting value, the texture and detail of the image become sharper. Noise Filtering: When you increase the setting value, the noise (picture roughness) becomes less prominent. Test: On/Off: Switches “On” and “Off” at a certain frequency to check the effect of “Reality Creation.”* ⁴ Off: The “Reality Creation” function is not applied.
Contrast Enhancer	Corrects the level of bright and dark parts automatically to optimize contrast according to a scene. Increases image sharpness and makes image dynamic. High/Middle/Low: You can adjust the contrast enhancer. Off: The “Contrast Enhancer” function is not applied.
Gamma Mode	2.2: Equivalent to a 2.2 gamma curve. 2.4: Equivalent to a 2.4 gamma curve. Gamma 3: Applies a gamma curve that prioritizes the brightness to suit use in a relatively bright environment. Gamma 4: Enhances black and white contrast to suit use in a relatively dark environment. DICOM GSDF Sim.*⁵: Gamma setting is in accordance with the Grayscale Standard Display Function (GSDF) of the Digital Imaging and Communications in Medicine (DICOM) standards.
Color Space	Converts the color space. Custom 1: Produces images with vivid colors. Custom 2: Produces images with muted colors. Custom 3: Reproduces image colors true to the original image source. You can select R/G/B for the selected color space and adjust the R/G/B chromaticity points in the x and y directions in the CIExy chromaticity diagram respectively. Color Select: Select the color to adjust from “Red,” “Green,” and “Blue.” Cyan - Red (x): Adjusts the chromaticity point of the selected color toward cyan-red (x). Magenta - Green (y): Adjusts the chromaticity point of the selected color toward magenta-green (y).

Setting items	Description
Color Correction	<p>On: Adjusts the hue, saturation, and brightness for the selected color. Repeat steps 1 and 2 described below to specify the target color.</p> <p>1 Press $\blacktriangle/\blacktriangledown$ to select “Color Select,” then press $\blacktriangleleft/\blacktriangleright$ to select the color you want to adjust among “Red,” “Yellow,” “Green,” “Cyan,” “Blue,” and “Magenta.”</p> <p>2 Press $\blacktriangle/\blacktriangledown$ to select “Hue,” “Saturation” or “Brightness,” then adjust them to suit your taste using $\blacktriangleleft/\blacktriangleright$ while watching the projected picture.</p> <p>Off: The “Color Correction” function is not applied.</p>
Film Mode ^{*6 *7}	<p>Auto: Precisely reproduces the image from a film source to suit the original film source. Normally, select this option.</p> <p>Off: Select this option if the images are rough around the edges when “Auto” is selected.</p>

Notes

- *1: When “Intelligent Setting” is set to “On,” “Picture Mode” cannot be set. Only “Custom” of “Light Output Mode” in “Light Settings” is selectable and other items cannot be set.
- *2: If you cannot find the appropriate option in “Location,” select the closest one. Usage location cannot be selected from “Location” for each input terminal.
- *3: The projector may not be able to maintain the brightness in an environment with a lot of dust and dirt.
- *4: The display position of the status during the test works together with the “Menu Position” setting (page 32).
- *5: Available when a computer signal is input from the DVI-D input terminal (INPUT B), HDMI input terminal (INPUT C), or HDBaseT input terminal (INPUT D). This projector is not to be used as a device for medical diagnosis.
- *6: When a video signal is input, this option is available.
- *7: When a progressive signal is input, this option is not available.

The Screen Menu

For adjusting the size, position, and aspect ratio of the projected image for each input signal.

Setting items	Description
Aspect ^{*1}	Changes the aspect ratio of the projected image (page 30).
When the computer signal is input	<p>Full 1: Displays the image to fit the maximum projected image size without changing the aspect ratio of the input signal.</p> <p>Full 2: Displays the image to fit the maximum projected image size.</p> <p>Normal: Displays the image on the center point of the projected image without changing the resolution of the input signal or enlarging the image.</p>
When the video signal is input	<p>4:3: Displays the image to fit the maximum projected image size with an aspect ratio fixed to 4:3.</p> <p>16:9: Displays the image to fit the maximum projected image size with an aspect ratio fixed to 16:9.</p> <p>Full: Displays the image to fit the maximum projected image size.</p> <p>Zoom: Display the center point of the projected image to zoom.</p>
V Center ^{*2 *3}	Adjust the whole projected image by moving up and down on the screen. As the selected number increases, the screen moves up, and as the selected number decreases, the projected image moves down.
Vertical Size ^{*2 *3}	Reduces or enlarges the image vertically. The projected image is enlarged as the setting increases and reduced as the setting decreases. If the subtitle of a movie, etc. cannot be seen, use this together with “V Center.”
Overscan ^{*2}	On/Off: Hides the outline of the image when set to “On.” Select “On” if noise appears along the edge of the image.
Adjust Signal ^{*6}	Adjusts the image of a computer signal. Use this item if the edge of the image is cut and reception is bad.
APA ^{*4 *5}	Automatically adjusts the projected image to an optimum quality when you press the ENTER key.
Phase ^{*4}	Adjusts the dot phase of the display pixel and the input signal. Set to the value where looks clearest.
Pitch ^{*4}	The higher the setting, the wider the horizontal image elements (pitch). The lower the setting, the narrower the horizontal image elements (pitch).
Shift ^{*6}	<p>H: The higher the setting, the farther right the image is projected on the screen. The lower the setting, the image farther left.</p> <p>V: The higher the setting, the farther up the image is projected on the screen. The lower the setting, the image farther down.</p>

Notes

- *1: • Note that if the projector is used for profit or for public viewing, modifying the original picture by switching to the aspect mode may constitute an infringement of the rights of authors or producers, which are legally protected.
- Depending on the input signal or “Screen Aspect” setting, setting items for aspect ratio or some other setting items cannot be set in some cases, or changing the aspect ratio setting may have no effect.
 - A part of the image may be displayed in black, depending on the setting item.

- *2: Available when a video signal is input from the RGB/YPbPr input terminal (INPUT A), DVI-D input terminal, HDMI input terminal, and HDBaseT terminal.
- *3: Available when “Aspect” is “Zoom” and “Screen Aspect” is 16:10 or 16:9.
- *4: Available when a computer signal is input from the RGB/YPbPr input terminal (INPUT A).
- *5: If the projected image includes a large amount of black portion around it, the APA function will not work properly and a part of the image may not be displayed on the screen. In addition, an optimum image cannot be obtained, depending on the type of input signal. In this case, adjust the “Phase,” “Pitch,” and “Shift” items manually.
- *6: Available when a computer or video signal is input from the RGB/YPbPr input connector (INPUT A). This option is available only when “Aspect” is set to “Zoom.”

Aspect

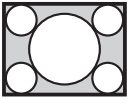
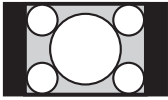
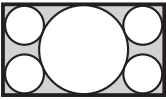
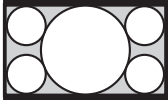
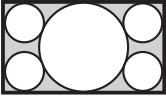
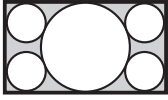
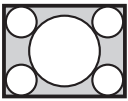
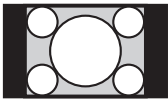
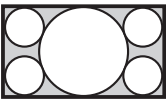
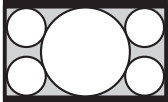
	Input signal	Recommended setting value and projected image
Computer signal	(4:3) 	(Full 1) ^{*1 *2} 
	(16:9) 	(Full 1) ^{*1 *2} 
	(16:10) 	(Full 1) ^{*1} 
Video signal	(4:3) 	(4:3) ^{*3 *5} 
	(16:9) 	(16:9) ^{*4 *5} 

*1: If you select “Normal,” the image is projected in the same resolution as the input signal without changing the aspect ratio of the original image.



*2: If you select “Full 2,” the image is projected to fit the projected image size, regardless of the aspect ratio of the image.



*3: Depending on the input signal, the projected image may be projected as illustrated below. In this a case, select “16:9.”



*4: Depending on the input signal, the image may be projected as illustrated below. In this a case, select “Zoom.”



*5: If you select “Full,” the image is projected to fit the projected image size, regardless of the aspect ratio of the image.





The Function Menu

The Function menu is used for setting various functions of the projector.









Setting items	Description
Audio Output Vol.	The higher the setting, the higher an audio level output from the audio output terminal. The lower the setting, the lower the audio level.
Smart APA	On/Off: When set to “On,” executes APA automatically when a signal is input.*1
CC Display	CC1/CC2/CC3/CC4/Text1/Text2/Text3/Text4: Select the closed caption service (Captions or Text). Off: Closed caption does not appear.
Background*2	Blue/Black/Image: Sets the background for when there is no input signal. When set to “Image,” the Start Up Image is displayed.
Start Up Image	On/Off: When set to “On,” the Start Up Image is displayed on the screen upon startup of the projector.
Color Calibration*3*4	Corrects color drift on the entire screen that has occurred over time. Auto: If you select “On,” it corrects color drift automatically when the projector is turned off after certain time of use. Start: When twenty minutes have passed after the light has been turned on, it immediately corrects color drift. Return*5: Restores the settings when performing the previous color calibration. Reset: Restores the factory default settings.
All Reset	All settings are initialized to their factory preset values.

Notes

- *1: Executes APA when a computer signal is input via the RGB/YPrPb input terminal (INPUT A).
- *2: When using the Twin Picture display mode and there is no input signal, the background will be black even if you set this item to “Image.”
- *3: The color calibration pattern is displayed while selecting this menu.
When you press the  button on the projector or the  button on the Remote Commander, the pattern is turned off and this menu is disabled.
- *4: Color drift may not be corrected properly due to environmental factors, such as temperature and dust, or changes over time.
- *5: You cannot select this if you have not performed the color calibration.

The Operation Menu

The Operation menu is used for setting for the operations by using the menu or the Remote Commander.

Setting items	Description
Language	Selects the language used in the menu and on-screen displays.
Menu Position	Bottom Left/Center: For selecting the position of the menu displayed on the projected image.
Status	On: All on-screen statuses are enabled. Off: Displays only the menus and warning messages. All Off: Turns off the on-screen displays, other than certain menus. *1 *2
IR Receiver	Front & Rear/Front/Rear: Selects the remote control receivers (IR Receiver) on the front and rear of the projector.
ID Mode	All/1/2/3/4: Assigns an ID number to the projector. When set to “All,” you can control the projector with the Remote Commander independently of the assigned ID Mode. Refer also to “ID MODE switch” of the Remote Commander on page 7.
Security Lock ^{*3}	On/Off: This function enables restriction of the projector to authorized users by password. The setting procedures for security locking are as follows: <ol style="list-style-type: none">1 Select “On” then press the ENTER key to display the setting menu.2 Input the password with the MENU, , , , and ENTER keys. (The default password setting is “ENTER, ENTER, ENTER, ENTER.”)3 Input a new password with the MENU, , , , and ENTER keys.4 Enter the password again to confirm. Enter the password when you turn on the projector after disconnecting and reconnecting the AC power cord. When it is set to “Off,” you can cancel the security lock. You are required to input the password again. If you fail to enter the correct password after three consecutive times, the projector cannot be used. In this case, press the  key to go standby mode then turn on the power again.
Control Key Lock	On/Off: When set to “On,” locks all the control keys of the projector. However, you can enable operation by performing the following even when “Control Key Lock” is set to “On.” <ul style="list-style-type: none">• Press and hold the  key for approximately 10 seconds during standby mode.<ul style="list-style-type: none">→ The projector turns on.• Press and hold the MENU key for approximately 10 seconds during power on.<ul style="list-style-type: none">→ “Control Key Lock” is set to “Off” and enables operation of all control panel keys on the projector.
Lens Control	On/Off: When set to “On,” you can adjust the lens (focus, zoom, and lens shift) from the Remote commander or the projector. To prevent unintentional operation, set it to “Off” after adjusting the lens.

Note

*1: When “All Off” is selected, warning message for high temperature is not displayed.

*2: Note that Sony is not liable for failure of the unit or any accident caused by selecting “All Off.”

*3: You will not be able to use the projector if you forget your password. If you call qualified Sony personnel because you have forgotten the password, you will be asked to verify the projector’s serial number and your identity. (This process may differ in other countries/regions.) Once your

identity has been confirmed, we will provide you with the password.

The Connection/Power Menu

The Connection/Power menu is used for setting for the connections and power.

Setting items	Description
Network Setting	
IPv4 Setting ^{*1}	
IP Address Setup	Auto(DHCP): The IP address is assigned automatically from the DHCP server such as a router. Manual: To specify the IP Address manually.
IP Address/ Subnet Mask/ Default Gateway/Primary DNS/Secondary DNS	When “Manual” is selected for “IP Address Setup,” select the item with the ◀ or ▶ key and input the value with ▲ or ▼ key. When all items are entered, select “Apply” then press the ENTER key. The entered settings will be registered.
IPv6 Information	Displays the IPv6 address information. When setting the address of IPv6, set it from the browser (page 45).
HDBaseT Settings	
LAN Setting	via HDBaseT/LAN Port: You can select either via the LAN of the HDBaseT equipment connected to the HDBaseT terminal or via the network connection with the LAN terminal of the main unit. ^{*2}
RS-232C Setting ^{*3}	via HDBaseT: You can connect this unit to the RS-232C terminal via the HDBaseT transmitter. (Baud rate: 9,600 bps) RS-232C: Use when connecting to the RS-232C terminal of this unit directly.
Extron XTP	On/Off: Set to “On” when connecting the HDBaseT terminal of this unit to XTP Systems ^{*4} manufactured by Extron Electronics. Set to “Off” when connecting to other equipment.
Dynamic Range ^{*5}	Sets the image input level of the INPUT B/C/D terminal. Auto: Distinguishes the image input level automatically. Limited: Set when the image input level is 16-235. Full: Set when the image input level is 0-255.
HDMI Cable	Long/Normal: Select “Long” when the image is disturbed or not projected.
Input-A Signal Sel.	Auto/Computer/Video GBR/Component: When set to “Auto,” selects the type of video signal input automatically when “Input-A” is selected with the INPUT key. ^{*6}
Color System	Auto/NTSC^{3.58}/PAL/SECAM/NTSC^{4.43}/PAL-M/PAL-N: When set to “Auto,” selects the color system automatically when “Video” is selected with the INPUT key. ^{*6}
ECO	
Auto Power Saving	
With No Input	Light Cutoff: The light turns off automatically and power consumption is reduced if no signal is input for about two minutes. The light turns on again when a signal is input or any key is pressed. In Light Cutoff, the ON/STANDBY indicator lights in orange. (page 49) Standby^{*7}: If no signal is input to the unit for about two minutes, the power turns off automatically, and the unit enters standby mode. Off: The “With No Input” function is disabled.

Setting items	Description
With Static Signal	<p>Light Dimming^{*8 *9}: If an image does not change for about 10 seconds, light output is gradually reduced (approximately 10% to 15%^{*10}) from that set in the Light Output Mode. This setting provides a convenient way to reduce power consumption. In addition, the light automatically darkens slowly to approximately 5% of its light output if the selected time (“5 min.,” “10 min.,” “15 min.,” “20 min.,” or “Demo.”) elapses with no change to input signal. While dimming the light, the message “Light Dimming” appears. If you select “Demo.,” the image will start to darken about 40 seconds later. When any change in signal is detected, or an operation (remote control or control panel) is performed, normal brightness is restored.</p> <p>Off: The “With Static Signal” function is disabled.</p>
Standby Mode ^{*11}	<p>Standard/Low: When set to “Standard,” power consumption becomes higher in Standby mode. For details, see “Power consumption (Networked Standby Mode)” in “Specifications” (page 59).</p>
Quick Reboot	<p>Off/10 min./30 min.: After you turn off the power, the projector is in standby mode for a quick start within the specified time (10 minutes or 30 minutes). The ON/STANDBY indicator lights in orange when the projector is in standby mode. (page 49)</p>
Direct Power On	<p>On/Off: When set to “On,” you can turn the power on without going to standby mode when the AC power cord is connected to a wall outlet. You can also unplug the AC power cord without going to standby mode when you turn off the projector.</p> <p>You may unplug the AC power cord without going to standby mode.</p>

Notes

- *1: Set the IP address of this unit manually after connecting to the network. If this unit is not connected to the network, the setting is not enabled.
- *2: When connecting via HDBaseT, only the 100BASE-TX can be used for connection. When using the LAN terminal of the main unit, you can connect with the 10BASE-T/100BASE-TX.
- *3: When connecting via HDBaseT, the connection is at 9,600 bps. When using the RS-232C terminal of the main unit, you can connect at 38,400 bps.
- *4: For details on XTP Systems, refer to the product catalog or brochure from Extron Electronics.
- *5: If the image input setting of the HDMI connection equipment is not correct, the brighter part becomes too bright and the darker part becomes too dark.
- *6: The image may not be adjusted properly depending on the type of input signal. In such a case, adjust it manually to suit to the connected equipment.
- *7: Select “Off” to avoid entering standby mode when there is no input signal.
- *8: A change in signal may not be detected depending on the input image. If “With No Input” is set, it takes priority.
- *9: As the light is dimmed gradually, you may not notice any change in brightness.
- *10: This varies depending on the “Light Output Mode” setting (page 26).
- *11: When “Standby Mode” is set to “Low,” the network and network control function cannot be operated while the projector is in standby mode.

The Installation Menu

The Installation menu is used for installing the projector.

Setting items	Description
Screen Fitting	<p>Adjusts the distortion of the projected image that occurs due to installation conditions or when a portion of the image spreads beyond the screen.*¹</p> <p>Warping: Select an adjustment point and move it vertically/horizontally to adjust the image distortion.</p> <p>V Keystone: Adjusts the vertical keystone distortion. The higher the setting, the narrower the upper side of the projected image. The lower the setting, the narrower the lower side of the projected image.*²</p> <p>H Keystone: Adjusts the horizontal keystone distortion. The higher the setting, the shorter the right side of the projected image.*² The lower the setting, the shorter the left side of the projected image.*²</p> <p>V Linearity: Adjusts the projected image so that the height of the upper half and lower half will be the same. The higher the setting, the narrower the upper half of the projected image. The lower the setting, the narrower the lower half of the projected image.</p> <p>H Linearity: Adjusts the projected image so that the width of the right half and left half will be the same. The higher the setting, the narrower the right half of the projected image. The lower the setting, the narrower the left half of the projected image.</p> <p>Reset: Resets all of the Screen Fitting items.</p>
Multi Screen	<p>When composing one screen with multiple projections, you can overlap portions of different projections or tile the projections.</p>
Color Space	<p>Changes the color space. The same adjustments as in “Color Space” (page 26) in the Projection Setting menu are available.</p>
Color Matching* ³	<p>Adjusts the overall brightness and hue of the projected image.</p> <p>Adjust: Select one of 6 signal levels and adjust the brightness or hue.</p> <p>Level 1 - 6: Select the brightness level to adjust.</p> <p>Brightness: Adjusts the brightness of the selected brightness level.</p> <p>Color: Adjusts the hue of the selected brightness level.</p> <p>Reset: Resets all of the adjusted values.</p>
Edge Blending	<p>Sets the settings regarding edge blending.</p> <p>Reset: Resets all of the Blend Settings, Blend Fitting, and Zone Black Level Adj. values.</p>

Setting items	Description
Blend Settings	<p>Configure the Edge Blending setting for the top, bottom, right, and left of the screen respectively.</p> <p>Left/Right/Top/Bottom: Set the Edge Blending effect for each position.</p> <p>Edge Blending: Set “On” to set “Blending Range” or “Blend Start Pos.”</p> <p>Blending Range: Set the width where images are overlapped.</p> <p>Blend Start Pos.: Set the start position from which images are overlapped.</p> <p>Blend Cursor: Displays the cursors at the start and end positions for edge blending. When set to “On,” the cursors are displayed during Blend settings.</p> <p>Start Pos. Color: Select the color of the cursor that indicates the start position.</p> <p>End Pos. Color: Select the color of the cursor that indicates the end position.</p> <p>Reset: Resets all of the Blend Settings values.</p>
Blend Fitting	<p>Finely adjusts the overlapped part.</p> <p>Adjust: Specify a position in the overlapped area and move image pixels. Use $\blacktriangle/\blacktriangledown/\blacktriangleleft/\blacktriangleright$ to select the position to adjust. Press the ENTER key to determine the position and use $\blacktriangle/\blacktriangledown/\blacktriangleleft/\blacktriangleright$ to move the image pixels vertically/horizontally so that neighboring images overlap.</p> <p>Reset: Resets all of the Blend Fitting values.</p>
Zone Black Level Adj. ^{*4} _{*5 *6}	<p>Adjusts so that the overlapped part is not noticeably bright when a dark image is displayed.</p> <p>Select the correction zone “Adjust Zone 1” through “Adjust Zone 9,” and set the adjustment values.</p> <p>Zone Fitting: Adjusts the area of each correction zone.</p> <p>Adjust: Specifies the position of the marginal line of each correction zone.</p> <p>Select the adjusting position using $\blacktriangle/\blacktriangledown/\blacktriangleleft/\blacktriangleright$. Press the ENTER key to determine the position and use $\blacktriangle/\blacktriangledown/\blacktriangleleft/\blacktriangleright$ to move the image pixels vertically/horizontally so that the area of each correction zone is adjusted.</p> <p>Reset: Resets all of the Zone Fitting values.</p> <p>Black Level Adj.: Adjusts the brightness of each correction zone.</p> <p>Reset: Resets all of the Black Level Adj. values.</p> <p>Reset: Resets all of the Zone Black Level Adj. values.</p>
Image Split	<p>Off/Left-side Area/Right-side Area: Divides the input signal from the computer in half, and displays an enlarged image of the left-side or right-side area on the screen.^{*7}</p>
Image Flip	<p>HV/H/V/Off/Auto: Flips the projected image horizontally and/or vertically according to the installation method.</p>
High Altitude Mode	<p>On/Off: Set to “On” when using the projector at an altitude of 1,500 m or higher. Continuing to use the wrong setting may affect component reliability.</p>
Filter Cleaning	<p>Turns off the projector and cleans the air filter.^{*8}</p>
Filter Box (Op)	<p>Installed/Not Installed: Set to “Installed” when using Projector Filter Box (PK-F60FB1.)</p>
Screen Aspect	<p>16:10/16:9/4:3: For switching the display area to suit to the screen.</p>

Setting items	Description
Blanking	This feature allows you to adjust the displayable region within the four directions of the projection surface. Select the edge to adjust from “Left,” “Right,” “Top,” and “Bottom” using the ▲/▼ keys. Adjust the amount of blanking using the ◀/▶ keys. *9
Panel Alignment *10	This feature allows you to adjust the gaps in the color of characters or the picture. When set to “On,” “Adjust Color” and “Pattern Color” can be assigned and adjusted. Adjust Item: Selects how to make adjustments from below. Shift: Shifts the whole picture and makes adjustments. Zone: Selects the desired range and makes adjustments. Adjust Color: Assigns the desired color to adjust the gaps in color. Select “R” (Red) or “B” (Blue) to make adjustments based on “G” (Green). Pattern Color: Select “R/G” (Red and Green) or “R/G/B” (White, all colors) when “Adjust Color” is “R” (Red). Select “B/G” (Blue and Green) or “R/G/B” (White, all colors) when the “Adjust Color” is “B” (Blue). Adjust: The shift adjustment and zone adjustment of the color selected in “Adjust Color” can be made with ▲/▼/◀/▶ keys. Reset: The panel alignment settings are initialized to their factory preset values.
Uniformity	This feature allows you to adjust color uniformity. Select the appropriate brightness level from level 0 to level 11. Also, select the desired range to adjust the color. Level: Select the brightness level (0-11) to adjust the brightness of the screen. Area: Top Left: Select the top-left point to specify the adjustment range. Area: Bottom Right: Select the bottom-right point to specify the adjustment range. R: Adjusts the red level in the selected range. G: Adjusts the green level in the selected range. B: Adjusts the blue level in the selected range. Reset: Resets all of the adjusted values.

Notes

- *1: Since the Keystone/Warping/Linearity adjustment is an electronic correction, the image may deteriorate.
- *2: Depending on the position adjusted with the lens shift feature, the aspect ratio of the image may change from the original or projected image may be distorted with Keystone adjustment.
- *3: The brightness and color of the projected image may not match completely, even after you adjust “Brightness” and “Color.”
- *4: You cannot adjust anything other than the targeted adjustment zones in “Black Level Adj.”
- *5: When selecting the correction zone of “Black Level Adj.,” the targeted correction zone flashes twice.
- *6: When entering the Zone Fitting adjustment, the whole screen flashes twice to indicate the division state of the area.
- *7: If the Screen Aspect is set to 16:10 and input signal is 16:10 or 16:9, the image will be projected at the correct aspect. This function is not available when displaying two pictures.
- *8: Normally, filter cleaning is performed automatically. However, it is not performed when the projector is installed at an angle within the range illustrated below.

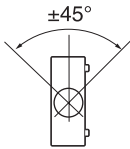

- *9: When the projected image is displayed smaller than the entire projection surface using the Aspect or Screen Aspect setting, blanking may not be applied.
- *10: Depending on the adjustment value of "Panel Alignment," the color and resolution may be changed.

i The Information Menu

The Information menu enables you to confirm various information on the projector, such as the total usage hours of a light.

Items	Description
Model Name	Displays the model name.
Serial No.	Displays the serial number.
fH / fV (horizontal frequency/vertical frequency)* ¹	Displays the horizontal frequency/vertical frequency/signal type of the current input signal.
Light Timer	Indicates the total usage time of a light.

Note

*1: These items may not be displayed depending on the input signal.

Using Network Features

Connection to the network allows you to perform the following:

- Checking the current status of the projector.
- Remotely controlling the projector.
- Receiving the e-mail report for the projector.
- Making the network settings for the projector.
- Monitoring networks and supporting control protocol (Advertisement, ADCP, PJ Talk, PJ Link, PJ Control API, SNMP, AMX DDDP [Dynamic Device Discovery Protocol], Crestron RoomView).
- Restoring the network settings to their factory defaults.

Notes

- When connecting this projector with the network, consult with the network administrator. The network must be secured.
- When using this projector connected with the network, access the control window via a Web browser and change the access limitation of the factory preset values (page 42). It is recommended to change the password regularly.
- When the setting on the Web browser is completed, close the Web browser to log out.
- Supported Web browsers are Internet Explorer (version 11 or later) and Safari (version 11 or later).
- The menu displays only English.
- If the browser of your computer is set to [Use a proxy server] when you have access to the projector from your computer, click the check mark to set accessing without using a proxy server.
- SNMP, AMX DDDP, and Crestron RoomView do not support IPv6.
- The following menu displays used for the explanation may be different depending on the model you are using.

Displaying the Control Window of the Projector with a Web Browser

- 1 Connect the LAN cable (page 12).
- 2 Set the network settings for the projector using “Network Setting” in the Connection/Power menu (page 34).
- 3 Start a Web browser on the computer, enter the following in the address field, then press the Enter key on your computer.

http://xxx.xxx.xxx.xxx

(xxx.xxx.xxx.xxx: IP address for the projector)

When connecting with the IPv6 address

http://[xxxx:xxxx:••• xxxx]

You can confirm the IP address of the projector under “Network Setting” in the Connection/Power menu (page 34).

The following window appears in the Web browser.

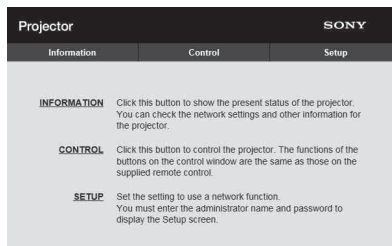

Once you make the network settings, you can open the control window only by performing step 3 of this procedure.

Operating the control window

Switching the page

Click one of the Page Switching buttons to display the desired setting page.



Page Switching buttons

Setting the access limitation

You can limit a user for accessing any particular page.

Administrator: Allowed access to all pages

User: Allowed access to all pages except the Setup page

When you access the Setup page for the first time, input “root” as the user name and “Projector” as the password in the authentication dialog.

When you log in for the first time, the window that prompts you to change the password is displayed. Follow the instructions on the screen to change the password.

The name of the administrator is preset to “root.”

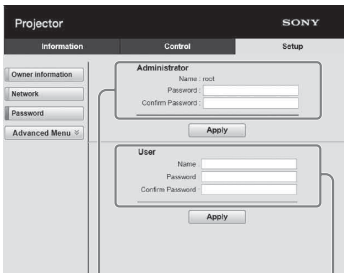
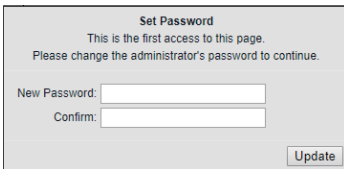

Entry area for [Administrator]

Entry area for [User]

The password can be changed in the Password page in the Setup page.

The password of the administrator and user should be 8 to 16 characters that includes both alphabet and numeric characters. Alphabet is case-sensitive.

The default password “Projector” cannot be set as a new password.

Note

If you forget your password, consult with qualified Sony personnel.

The password will be reset with your permission.

Confirming the Settings for the Projector

You can confirm the current settings for the projector on the Information page.

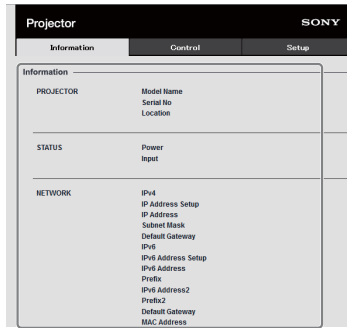

Information area

Operating the Projector from a Computer

You can control the projector from the computer on the Control page.

The functions of the buttons shown in the operation area are the same as those of the keys on the supplied Remote Commander.

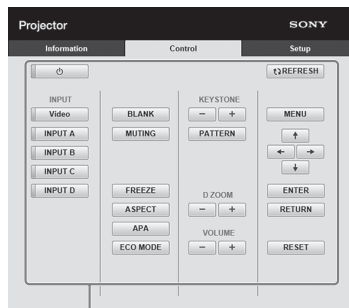

Operation area

Using the e-mail Report Function

Set the e-mail report function on the Setup page.
Entered values will not be applied unless you click on [Apply].

Notes

- The e-mail report function is not available on the network where Outbound Port25 Blocking is used and cannot connect to the SMTP server.
- You cannot enter the following characters in the text box: “'”, “””, “\”, “&”, “<”, “>”

- 1 Click on [Owner information] to enter the owner information recorded in the e-mail report.

The screenshot shows the 'Projector' setup interface with the 'Information' tab selected. The 'Owner Information' section is active, displaying fields for 'Name', 'Organization', 'Projector', and 'Location'. A 'Memo' field is also present. An 'Apply' button is at the bottom right of the section. A line points from the 'Owner information button' label to the 'Owner Information' button in the left sidebar.

Owner information button

- 2 Click on [Advanced Menu], then [E-mail] to display the E-mail page.
Set the timing of the e-mail report.
Maintenance Reminder: Set the timing for maintenance. To reset Maintenance Reminder, check the RESET box and then click on [Apply].

The screenshot shows the 'Projector' setup interface with the 'Information' tab selected. The 'Advanced Menu' section is active, showing options for 'OWNER INFORMATION', 'NETWORK', 'PASSWORD', and 'ADVANCED MENU'. A line points from the 'Advanced Menu button' label to the 'Advanced Menu' button in the left sidebar.

Advanced Menu button

The screenshot shows the 'Projector' setup interface with the 'Information' tab selected. The 'E-mail' section is active, displaying 'Report Timing' (Lamp Reminder, Maintenance Reminder, Elapsed Hours) and 'Mail Account' settings (Email Address, Mail Address, Outgoing Mail Server, Authentication options). A line points from the 'E-mail button' label to the 'E-mail' button in the left sidebar.

E-mail button

- 3 Enter the outgoing e-mail address in the Address box then check the Report Timing box of the e-mail report to be sent.

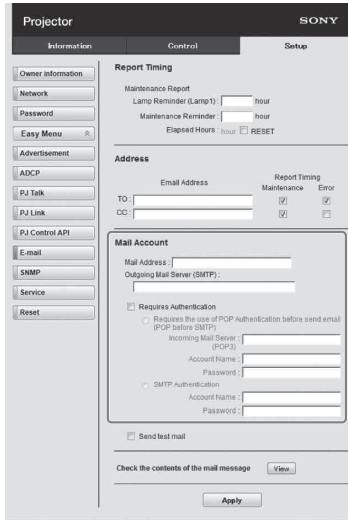
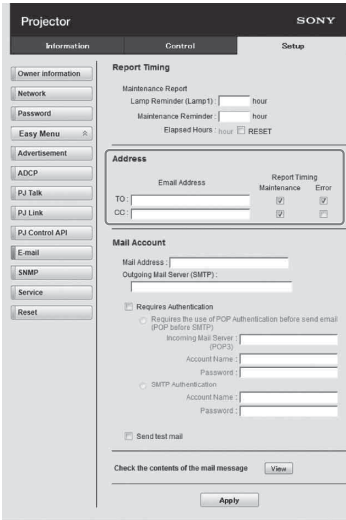

4 Set the mail account for sending e-mail reports.

Mail Address: Enter the e-mail address.
Outgoing Mail Server (SMTP): Enter the address of outgoing mail server (SMTP).

Required Authentication: Check this box if authentication is required for sending email.

Requires the use of POP Authentication before send email (POP before SMTP): Check this box to arrange for POP authentication to be performed before sending e-mail.

Incoming Mail Server (POP3): Enter the address of the incoming-mail server (POP3) to be used for POP3 authentication.

Account Name: Enter the mail account.

Password: Enter the password.

SMTP Authentication: Check this box to arrange for SMTP authentication to be performed before sending e-mail.

Account Name: Enter the mail account.

Password: Enter the password.

5 Confirm the content of the e-mail report.
 When you click on [View], the content of the e-mail reports are displayed.

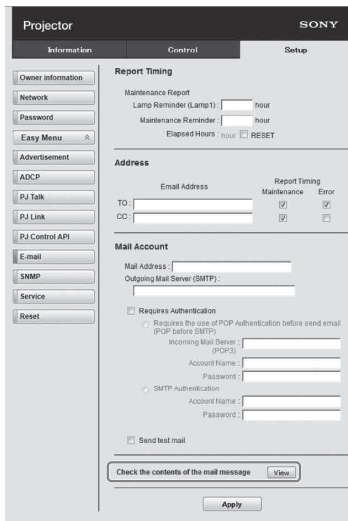

6 Send the test mail.
 To send your test mail to the preset e-mail address, check the Send test mail box then click on [Apply].

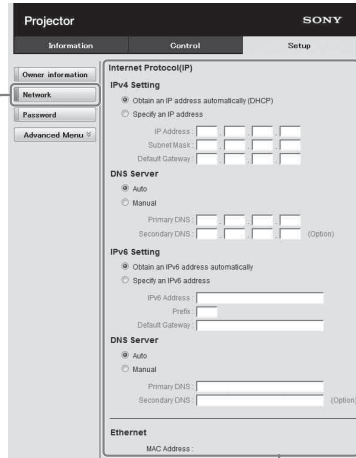
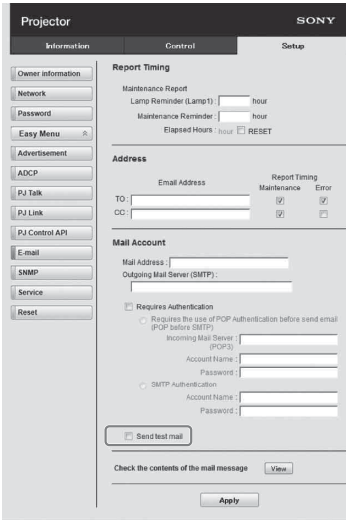

Network button

LAN Network setting area

Configure the Network Settings

You can configure the network settings for the projector in “Network Setting” of the Connection/Power menu. Also, you can set the network function on the Setup page. Entered values on the Setup page will not be applied unless you click on [Apply].

- 1 Click on [Network] to display the Network page.

- 2 Set the items for Internet protocol.

(a) IPv4/IPv6 address

Obtain an IP address automatically (DHCP):

Automatically provides the IP Address provided by a DHCP server.

Specify an IP address: Set the network manually.

-IP Address: Input the IP address of the projector.

-Prefix: For IPv6, input the prefix (bit) of the projector.

-Subnet Mask: Input the subnet mask of the projector.

-Default Gateway: Input the default gateway of the projector.

(b) DNS server

Auto: Automatically provides the IP Address provided by a DHCP server.

Manual

-Primary DNS: Input the primary DNS server of the projector.

-Secondary DNS: Input the secondary DNS server of the projector.

- 3 Set the items for Ethernet.

MAC Address: Displays the MAC address of the projector.

Setting the Control Protocol of the Projector

Change the settings for the control protocol on the Setup page. Entered values will not be applied unless you click on [Apply].

- 1 Click on [Advanced Menu] to display the Setup page.

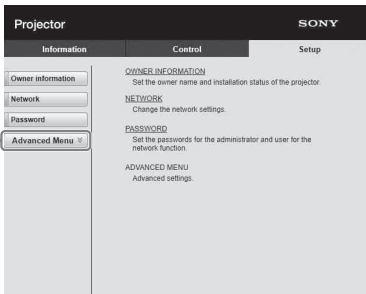

Advanced Menu button

- 2 Click on [Advertisement] to display the Advertisement page.

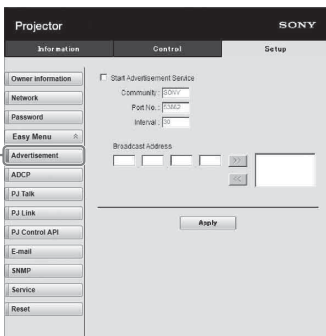

Advertisement button

Start Advertisement Service: Set Advertisement to enabled or disabled. Items for Advertisement are enabled only when this function is enabled. The factory default setting of this function is set to enabled.

-Community: Input the community name for Advertisement and PJ Talk. If the community name for

Advertisement is changed, the one for PJ Talk will also be changed. Only four alphanumeric characters can be input. The factory default setting is "SONY." To avoid unwanted access to the projector from other computers, changing the community name of the factory default is recommended.

- Port No.:** Input the transmit port of Advertisement. The factory default setting is "53862."
- Interval:** Input the transmission interval (seconds) of Advertisement. The factory default setting is "30."
- Broadcast Address:** Input the destination of data via Advertisement. If nothing is input, the data will be broadcast in the same subnetwork.

- 3 Click on [ADCP] to display the ADCP page.

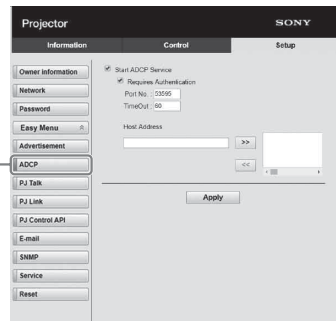

ADCP button

Start ADCP Service: Set ADCP to enabled or disabled. Items for ADCP are enabled only when this function is enabled. The factory default setting of this function is set to enabled.

- Requires Authentication:** Set the authentication for ADCP to enabled or disabled. The password is the same as that of the Web page administrator.
- Port No.:** Input the server port of ADCP. The factory default setting is "53595."
- Timeout:** Input the time (seconds) until ADCP communication is terminated in case it is disconnected. The factory default setting is "60."

-Host Address: Input the IP address that the ADCP server is allowed to receive. If no IP address is input, receiving commands will be allowed from any IP address. From the moment the IP address is input, access will be allowed only from that input IP address. For security reasons, it is recommended to input an IP address to restrict access.

4 Click on [PJ Talk] to display the PJ Talk page.



PJ Talk button

Start PJ Talk Service: Set PJ Talk to enabled or disabled. Items for PJ Talk are enabled only when this function is enabled. The factory default setting of this function is set to disabled.

-Community: Input the community name of Advertisement and PJ Talk. If the community name for PJ Talk is changed, the one for Advertisement will also be changed. Only four alphanumeric characters can be input. The factory default setting is “SONY.” To avoid unwanted access to the projector from other computers, changing the community name of the factory default is recommended.

-Port No.: Input the server port of PJ Talk. The factory default setting is “53484.”

-Timeout: Input the time (seconds) until PJ Talk communication is terminated in case it is disconnected. The factory default setting is “30.”

-Host Address: Input the IP address that the PJ Talk server is allowed to

receive. If no IP address is input, receiving commands will be allowed from any IP address. From the moment the IP address is input, access will be allowed only from that input IP address.

For security reasons, it is recommended to input an IP address to restrict access.

5 Click on [PJ Link] to display the PJ Link page.

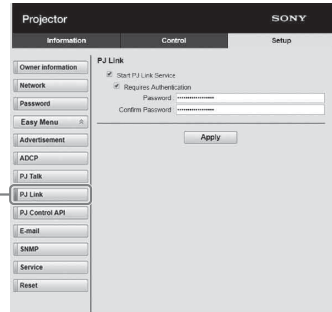

PJ Link button

Start PJ Link Service: Set PJ Link to enabled or disabled. Items for PJ Link are enabled only when this function is enabled. This function is enabled at the factory setting.

-Requires Authentication: Set the authentication for PJ Link to enabled or disabled.

-Password: Input the authentication password for PJ Link. For the factory default password, refer to the PJ Link specifications.

6 Click on [PJ Control API] to display the PJ Control API page.

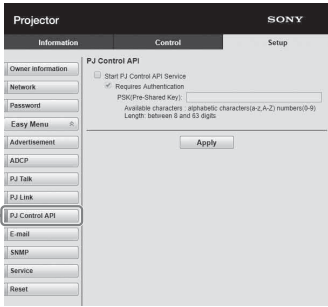

PJ Control API button

Start PJ Control API Service: Set PJ Control API to enabled or disabled. The factory default setting of this function is set to disabled.

-Requires Authentication: Set the authentication for PJ Control API to enabled or disabled.

-PSK(Pre-Shared Key): Input the PSK (Pre-Shared Key) for authentication. Only 8 to 63 alphanumeric characters can be input.

- Click on [Service] to display the Service page. The system service function is set.



Service button

Start DDDP Service: Set DDDP to enabled or disabled. For details, refer to the DDDP specifications from AMX Corporation. The factory default setting of this function is set to disabled.

Crestron Control: For details, refer to the product catalogues, etc., from Crestron Corporation.

-IP Address: Input the Crestron system server.

-IP ID(HEX): Input the IP ID(HEX) for the CIP protocol.

-Port No.: Input the port number for the CIP protocol server.

Resetting the network settings

Reset the network settings to their factory defaults.

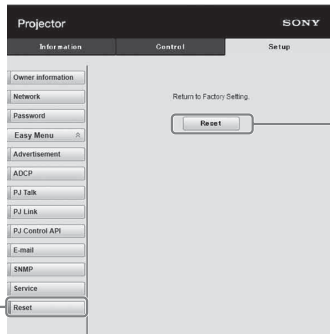

Reset button

Reset



Reset: Reset all Web browser settings to their factory defaults.

Indicators

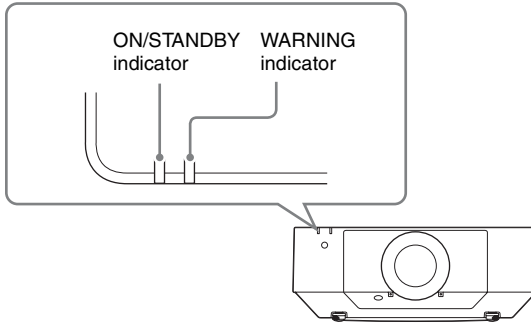
You can check the projector status or abnormality by checking the lighting/flashing status of the ON/STANDBY indicator and WARNING indicator on the front. If the indicators flash in red, address the problem in accordance with “Warning indicators and remedies” (page 50).

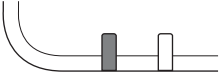

Operating status indication

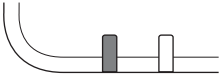
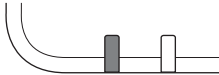
Indicator status	Operating status	Meaning
 <p>(Lights in red) (Off)</p>	Standby	The power is supplied to the projector and the projector is in a standby mode according to the setting.
 <p>(Flashes in green) (Off)</p>	Warm-up	The projector is warming up after it is turned on.
 <p>(Lights in green) (Off)</p>	Power on	The projector is ready for projection.
 <p>(Lights in orange)(Off)</p>	Other standby status	The projector is in With No Input (Light Cutoff), or Quick Reboot standby mode.

Warning indicators and remedies

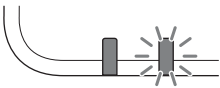
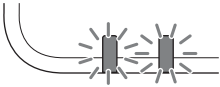
Indicator status	The number of flashes	Meaning	Remedies
 <p>(Lights in red) (Flashes in red)</p>	Twice	The side cover or air filter is not installed securely.	Check how the side cover or air filter is attached and install it securely.
	Three times	The light source does not light properly.	Unplug the AC power cord and make sure the ON/STANDBY indicator turns off, then plug the AC power cord into the wall outlet and turn on the projector.
	Six times	A strong shock to the projector is detected.	If there is no visible abnormality, unplug the AC power cord and make sure the ON/STANDBY indicator turns off, then plug the AC power cord into the wall outlet and turn on the projector.
 <p>(Flashes in red) (Flashes in red) Both indicators flash</p>	Eight times	The lens is not securely attached.	Check how the lens is attached and install it securely.
	Twice	The temperature in the projector is abnormal.	<ul style="list-style-type: none"> • Check if the air filter is clogged, then clean or replace it (page 55). • Check if the ventilation holes (intake/exhaust) are not blocked by the wall or an object and secure a sufficient gap. • Check the ambient temperature and use the projector within the range of operating temperature.

If the indicators flash in a manner other than described above, unplug the AC power cord and make sure the ON/STANDBY indicator turns off, then plug the AC power cord into the wall outlet and turn on the projector.

If the problem still persists, consult with qualified Sony personnel.

Messages List

When any of the messages listed below appears on the projected image, address the problem in accordance with the table below.

Message	Meaning/Remedy	Page
Clean the filter. Projector temperature is high. Switching to High Altitude Mode.	Temperature in the projector has increased. As a countermeasure against use at an altitude of 1,500 m or higher, set "High Altitude Mode" to "On." If you are not using the projector at a high altitude, perform the remedies below and set "High Altitude Mode" to "Off." <ul style="list-style-type: none"> • Check that the air filter is clogged, then clean or replace it. • Check that the ventilation holes (intake/exhaust) are not blocked by a wall or an object and secure a sufficient gap. • Check the ambient temperature and use the projector within the range of operating temperature. 	4, 55
Clean the filter. Projector temperature is high. The light will turn off in 1 minute.	Temperature in the projector has increased. Perform the remedies below. <ul style="list-style-type: none"> • Check that the air filter is clogged, then clean or replace it. • Check that the ventilation holes (intake/exhaust) are not blocked by a wall or an object and secure a sufficient gap. • Check the ambient temperature and use the projector within the range of operating temperature. • "High Altitude Mode" on this projector is set to "On." Set the setting that suits the operating environment. 	4, 55
Frequency is out of range!	Change the output setting of the connected equipment to one for signals supported by the projector.	63
Please check Input-A Signal Sel.	Set "Input-A Signal Sel." to "Auto" or select the input signal type to suit to the input signal.	34
Not applicable!	Invalid key pressed.	6
The control keys are locked!	"Control Key Lock" is set to "On."	32
Lens Control is locked!	"Lens Control" is set to "Off."	32
Function is locked!	The function is locked by external control.	6, 18, 19, 21, 36
Light Dimming	Reduces light output when "With Static Signal" is set. When any change in signal is detected, or an operation (remote control or control panel) is performed, normal brightness is restored.	35
Constant Brightness cannot be maintained.	Although "Constant Brightness" is selected, the brightness that is set cannot be maintained due to the lifetime of the light source. Consult with qualified Sony personnel.	26
Filter cleaning will start.	The filter will be automatically cleaned after the projector is turned off.	37
Filter cleaning completed.	The filter was automatically cleaned when the projector was turned on.	37

Troubleshooting

Before asking to have the projector repaired, try to diagnose the problem, following the instructions below.

Symptom	Remedy	Page
The power is not turned on.	Check if the AC power cord is firmly connected.	–
	When the “Control Key Lock” is set to “On,” you cannot turn on the projector using the I/⏻ key on the projector.	32
	Check how the air filter is attached and install it securely.	55
No image.	Check if the connecting cable is connected to external equipment properly.	8
	Check if the computer signal is set for output to an external monitor. If you set your computer, such as a notebook computer, to output the signal to both your computer’s display and an external monitor, the picture of the external monitor may not appear properly. Set your computer to output the signal to only an external monitor.	16
	Check if the input source is correctly selected.	16
	Check if an image is cut off.	7
	During “Zone Black Level Adj.” adjustment, a black image is automatically projected.	37
No image/image disturbance	Set “HDMI Cable” to “Long.”	34
The color of image has changed.	The color calibration may have been performed. To restore the color or the factory default settings, select “Return” or “Reset” in “Color Calibration.”	31
Unintended images are output.	The color calibration may be being performed. While performing the color calibration, the color calibration pattern is displayed automatically. Wait until the pattern turns off after completing the color calibration. When you press the I/⏻ button on the projector or the ⏻ button on the Remote Commander, the pattern is turned off and the color calibration function is disabled.	6, 31
On-screen display does not appear.	The on-screen display does not appear when “Status” in the Operation menu is set to “Off” or “All Off.”	32
The aspect ratio of the display is not right/the image is displayed smaller /a portion of image does not appear.	The image may not be displayed correctly with an input signal the projector cannot interpret correctly. In such a case, set “Aspect” manually.	28, 30
	Check if “Screen Aspect” is correctly selected.	37
The image is a trapezoid.	The images become trapezoidal because of the projection angle. In such a case, you can correct the trapezoidal distortion, using a Keystone feature.	6, 18, 36

Symptom	Remedy	Page
Edges of the image are cut off or dark.	If you use the lens shift function with a setting outside the recommended range, edges of the image may be cut off or appear dark. Use a setting within the normal range for the lens shift function.	65
The image is distorted.	Warping is set. Disable the warp correction feature.	19, 36
The image is dark/too bright.	The settings for “Brightness,” “Contrast,” and “Light Output Mode” affect brightness of the image. Check if the value is appropriate.	25
	“With Static Signal” is set to “On.”	35
	When video signal is not input, the light is dimmed to reduce power consumption.	34
	When the temperature around the unit is high, the brightness will be reduced to protect the unit.	–
The image is not clear.	Check if the projector is in focus.	17
	The picture will not be clear if condensation has accumulated on the lens. In such a case, let the projector sit for about two hours with the power on.	–
The image is noisy.	Check if the connecting cable is connected to external equipment properly.	8
No sound.	Check that the connecting cables between the projector and external video or audio equipment are securely connected.	8
	Check if the output setting of connected external audio equipment is set for output the audio signal from the projector.	–
	Audio is not output if audio muting is activated.	7
	Check if the “Audio Output Vol.” is set to minimum.	31
The Remote Commander does not work.	Check that the batteries are installed correctly.	–
	Check that the batteries are not exhausted.	–
	Check if the “ID Mode” of the projector corresponds to that of the Remote Commander.	7, 32
	Check the setting for “IR Receiver.”	32
The fan is noisy.	The sound from the fan is often greater than normal to cool the light source in the following cases. <ul style="list-style-type: none"> • When “Light Output Mode” is set to “Standard.” • When “Location” in “Intelligent Setting” is set to “Entertainment.” • The projector is in at high altitude. (“High Altitude Mode” is set to “On.”) • Temperature is very high. 	25, 26, 37
	<ul style="list-style-type: none"> • Check that the air filter is clogged, then clean or replace it. • Check that the ventilation holes (intake/exhaust) are not blocked by a wall or an object and secure a sufficient gap. 	4

Symptom	Remedy	Page
The projector suddenly restarted.	Turn the power off and then on again to check the operating status. If the symptom occurs frequently, consult with qualified Sony personnel.	–

Cleaning the Air Filter

When the message that prompts cleaning the air filter appears, clean the air filter.

If the dust cannot be removed from the air filter even after cleaning, replace the air filter with a new one.

For details on a new air filter, consult with qualified Sony personnel.

Caution

If you continue to use the projector even after the message is displayed, dust may accumulate, clogging it. As a result, the temperature may rise inside the unit, leading to a possible malfunction or fire.

- 1 Turn off the projector and disconnect the AC power cord from a wall outlet.
- 2 Slide the lock switch on the side cover toward UNLOCK to unlock the cover.

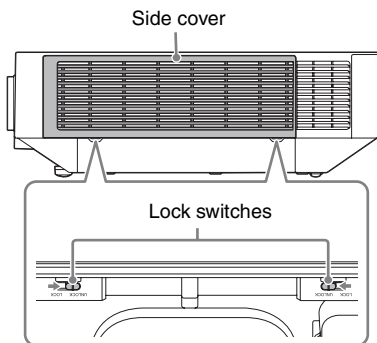

- 3 Slide the side cover downward by pushing its upper corners on both sides to remove the side cover.

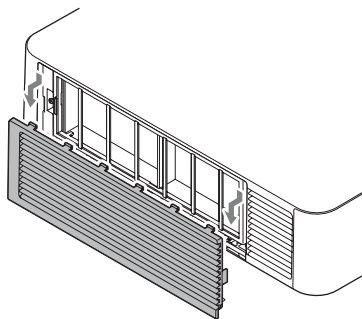

- 4 Loosen the screws (four) and pull out the filter cover by pinching the grab on the left side.

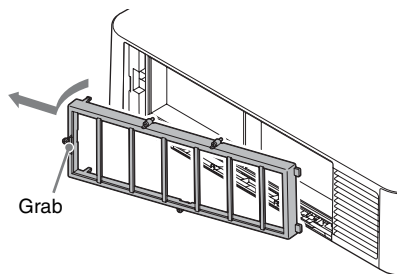
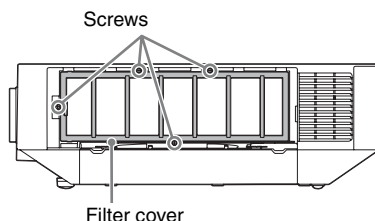

- 5 Pull out the air filter from the main unit.

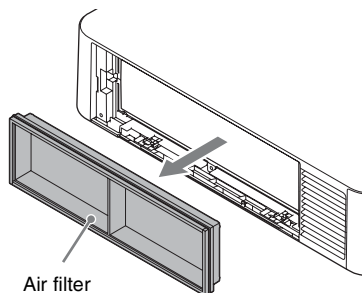

- 6** Clean the air filter with a vacuum cleaner.
- 7** Replace the air filter and attach the filter cover.
- When attaching the filter cover, fit the two tabs on the right into place, turn the filter cover using the right side as an axis, and fit the two tabs on the left into place. Then, tighten the four screws.

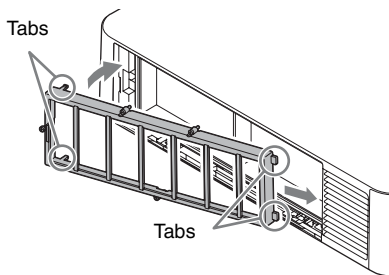

- 8** Fit the two tabs on the side cover into place and slide the side cover upward.

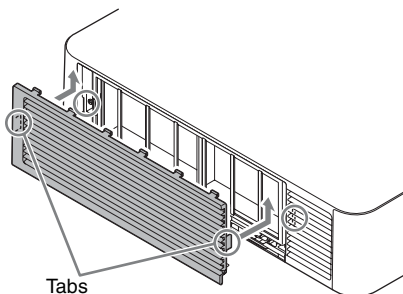

- 9** Lock the side cover.

Note

Be sure to attach the air filter firmly; the power cannot be turned on if it is not attached securely.

Replacing the Projection Lens

Notes

- Avoid removing/attaching the lens with the projector installed suspended from a ceiling.
- For usable projection lenses, see “Optional accessories” (page 60).
- Do not attach any lens other than the specified accessory lens sold separately.
- Be careful not to drop the projection lens.
- Avoid touching the lens surface.

Removing

- 1** Return the projection lens to the center position.
- While the unit is turned on, press the LENS SHIFT button on the Remote Commander, then press the RESET button on it. The projection lens returns to the center position.

Note

The projection lens cannot be removed unless it has returned to the center position.

- 2** Turn off the projector, then unplug the AC power cord from the wall outlet.

Caution

When replacing the lens, your eyes may be damaged if a strong light accidentally gets into your eyes. Before replacing the lens, turn off the projector and then unplug the AC power cord.

- 3** While pressing and holding down the LENS RELEASE button, rotate the

projection lens counterclockwise to pull out the lens straight.

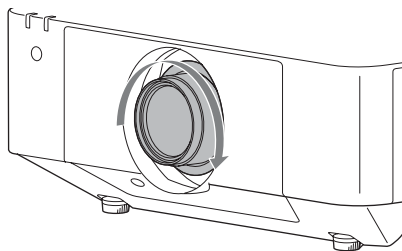
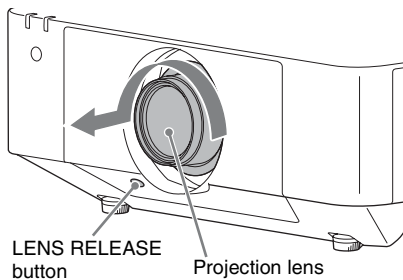

Note

When attaching the projection lens, do not press the LENS RELEASE button.

Attaching

- 1 Fully insert the projection lens with the index on the lens facing toward the top surface of the main unit.

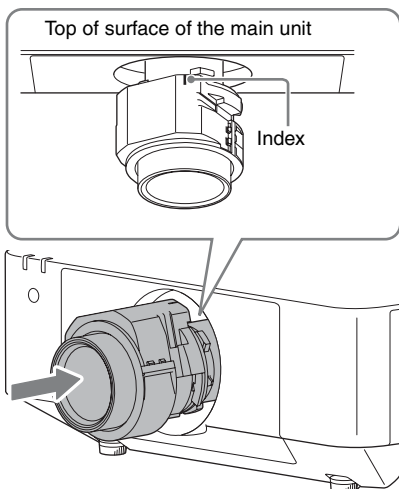

- 2 Rotate the lens clockwise until it clicks.

Specifications

Item	Description	
Display system	3 LCD system	
Display device	Size of effective display area	0.76" (19.3 mm) × 3, Aspect ratio 16:10
	Number of pixels	6,912,000 (1920 × 1200 × 3) pixels
Projection lens	Zoom	Electric zoom: 1.6 times
	Focus	Electric focus
Light source	Laser diode	
Projected image size	40 inches to 600 inches (1.02 m to 15.24 m)	
Light output	VPL-FHZ75: 6,500 lm ^{*1} (when "Light Output Mode" is set to "Standard") VPL-FHZ70: 5,500 lm ^{*1} (when "Light Output Mode" is set to "Standard")	
Displayable scanning frequency ^{*1}	Horizontal: 15 kHz to 92 kHz, Vertical: 48 Hz to 92 Hz	
Display resolution ^{*1}	Computer signal input	Maximum display resolution: 1920 × 1200 dots
	Video signal input	NTSC, PAL, SECAM, 480/60i, 576/50i, 480/60p, 576/50p, 720/60p, 720/50p, 1080/60i, 1080/50i, 1080/60p, 1080/50p, 1080/24p
Color system	NTSC ^{3.58} , PAL, SECAM, NTSC ^{4.43} , PAL-M, PAL-N, PAL60	
Computer and video signal input/output	INPUT A	RGB/YPbPr input terminal: Mini D-sub 15-pin female, G with sync/Y: 1 Vp-p ± 2 dB, sync negative, 75 ohms terminated, RGB/PbPr: 0.7 Vp-p ± 2 dB, 75 ohms terminated, Sync signal: TTL level high impedance, positive/negative Audio input terminal: Stereo mini jack, rated input 500 mVrms, input impedance more than 47 kilohms
	INPUT B	DVI-D input terminal: DVI-D 24-pin (Single link), DVI 1.0 compliant, HDCP support Audio input terminal: Shared with INPUT A
	INPUT C	HDMI input connector: HDMI 19-pin, digital RGB/YPbPr, HDCP support, HDMI audio support
	INPUT D	HDBaseT terminal: RJ45 HDBaseT transmittable signal: HDMI (Video, Audio), RS-232C, Ethernet (100BASE-TX) HDBaseT LAN cable: STP type (CAT5e or higher, straight, not supplied), Maximum length: 100 m
	VIDEO IN	Video input terminal: BNC, 1 Vp-p ± 2 dB, sync negative, 75 ohms terminated Audio input terminal: Shared with INPUT A

Item	Description	
	OUTPUT A	MONITOR output terminal: Mini D-sub 15-pin female, G with sync/Y: 1 Vp-p ± 2 dB, sync negative, 75 ohms terminated, RGB/PbPr: 0.7 Vp-p ± 2 dB, 75 ohms terminated, Sync signal: HD, VD 4 V (open), 1 Vp-p (75 ohms), positive/negative Audio output terminal: Stereo mini jack, stereo, 1 Vrms (maximum volume, when inputting 500 mVrms), output impedance 5 kilohms
	OUTPUT B	DVI-D output terminal: DVI-D 24-pin (Single link), DVI 1.0 compliant, non-HDCP compliant
Control signal input/output		RS-232C terminal: D-Sub 9 pin male
		LAN terminal: RJ45, 10BASE-T/100BASE-TX
		CONTROL S input terminal (DC power supply): Stereo mini jack, 5 Vp-p, Plug in power DC 5 V
Operating temperature/ Operating humidity		0 °C to 40 °C (32 °F to 104 °F)/20% to 80% (no condensation)
Storage temperature/ Storage humidity		-10 °C to +60 °C (14 °F to +140 °F)/ 20% to 80% (no condensation)
Power required		VPL-FHZ75: AC 100 V to 240 V, 5.4 A to 2.2 A, 50/60 Hz VPL-FHZ70: AC 100 V to 240 V, 4.9 A to 2.0 A, 50/60 Hz
Power consumption	AC 100 V to 120 V	VPL-FHZ75: 537 W VPL-FHZ70: 483 W
	AC 220 V to 240 V	VPL-FHZ75: 518 W VPL-FHZ70: 468 W
Power consumption (Standby Mode)	AC 100 V to 120 V	0.50 W (when “Standby Mode” is set to “Low”)
	AC 220 V to 240 V	0.50 W (when “Standby Mode” is set to “Low”)
Power consumption (Networked Standby Mode)	AC 100 V to 120 V	16.0 W (LAN), 20.7 W (HDBaseT), 20.7 W (All Terminals and Networks Connected) (when “Standby Mode” is set to “Standard”)
	AC 220 V to 240 V	13.3 W (LAN), 18.7 W (HDBaseT), 18.7 W (All Terminals and Networks Connected) (when “Standby Mode” is set to “Standard”)
Heat dissipation	AC 100 V to 120 V	VPL-FHZ75: 1,833 BTU/h VPL-FHZ70: 1,648 BTU/h
	AC 220 V to 240 V	VPL-FHZ75: 1,768 BTU/h VPL-FHZ70: 1,597 BTU/h
Outside dimensions		460 × 175 × 515 mm (18 ¹ / ₈ " × 6 ⁷ / ₈ " × 20 ⁹ / ₃₂ ") (W/H/D) 460 × 169 × 515 mm (18 ¹ / ₈ " × 6 ²¹ / ₃₂ " × 20 ⁹ / ₃₂ ") (W/H/D) (without protrusions)

Item	Description
Mass	Approx. 16 kg (34 lb)
Supplied accessories	See “Checking the Supplied Accessories” in the supplied Quick Reference Manual.
Optional accessories *2 *3 *4	<p>Projection Lens VPLL-3007: Manual focus, Projected image size: 60" to 300" (1.52 m to 7.62 m), Maximum external dimensions (W × H × D): 150 × 150 × 222 mm (5 ²⁹/₃₂" × 5 ²⁹/₃₂" × 8 ³/₄"), Mass: 1.7 kg (3.7 lb 60 oz)</p>
	<p>Projection Lens VPLL-Z3009: Manual focus/zoom, Projected image size: 60" to 300" (1.52 m to 7.62 m), Maximum external dimensions (W × H × D): 150 × 150 × 217 mm (5 ²⁹/₃₂" × 5 ²⁹/₃₂" × 8 ¹⁹/₃₂"), Mass: 1.7 kg (3.7 lb 60 oz)</p>
	<p>Projection Lens VPLL-Z3010: Electric focus/zoom, (when attaching to this projector), Projected image size: 60" to 300" (1.52 m to 7.62 m), Maximum external dimensions (W × H × D): 150 × 150 × 227 mm (5 ²⁹/₃₂" × 5 ²⁹/₃₂" × 9"), Mass: 2.0 kg (4 lb 6.5 oz)</p>
	<p>Projection Lens VPLL-Z3024: Electric focus/zoom, (when attaching to this projector), Projected image size: 40" to 600" (1.02 m to 15.24 m), Maximum external dimensions (W × H × D): 97 × 105 × 177 mm (3 ¹³/₁₆" × 4 ⁹/₆₄" × 6 ³¹/₃₂"), Mass: 1.2 kg (2.6 lb 42 oz)</p>
	<p>Projection Lens VPLL-Z3032: Electric focus/zoom, (when attaching to this projector), Projected image size: 40" to 600" (1.02 m to 15.24 m), Maximum external dimensions (W × H × D): 97 × 105 × 177 mm (3 ¹³/₁₆" × 4 ⁹/₆₄" × 6 ³¹/₃₂"), Mass: 1.2 kg (2.6 lb 42 oz)</p>
	<p>Projection Lens VPLL-3003: Electric focus/electric corner correction, (when attaching to this projector), Projected image size: 80" to 300" (2.03 m to 7.62 m), Maximum external dimensions (W × H × D): 229 × 193.7 × 424.7 mm (9 ¹/₃₂" × 7 ⁵/₈" × 16 ²³/₃₂"), Mass: 2.9 kg (6.4 lb)</p>
	Optical Filter LKRA-FL1
	Optical Filter LKRA-FL2
	Projector Suspension Support PSS-650
	Projector Suspension Support Joint Pole PSS-650P
	<p>Projection Lens Adapter PK-F60LA1^{*5}: Maximum external dimensions (when assembled, W × H × D): 106 × 96 × 124 mm (4 ³/₁₆" × 3 ²⁵/₃₂" × 4 ⁷/₈"), Mass (when assembled): 0.26 kg (0.6 lb)</p>
	<p>Projection Lens Adapter PK-F60LA2^{*5}: Maximum external dimensions (when assembled, W × H × D): 106 × 96 × 124 mm (4 ³/₁₆" × 3 ²⁵/₃₂" × 4 ⁷/₈"), Mass (when assembled): 0.26 kg (0.6 lb)</p>
	<p>Projection Lens Adapter PK-F60LA3^{*5}: Maximum external dimensions (W × H × D): 97 × 75 × 90 mm (3 ¹³/₁₆" × 2 ¹⁵/₁₆" × 3 ¹⁷/₃₂"), Mass: 0.24 kg (0.5 lb)</p>

Item	Description
	Projection Lens Adapter PK-F60LA4^{*5} : Maximum external dimensions (W × H × D): 97 × 75 × 90 mm (3 ¹³ / ₁₆ " × 2 ¹⁵ / ₁₆ " × 3 ¹⁷ / ₃₂ "), Mass: 0.24 kg (0.5 lb)

Notes

The values for mass and dimensions are approximate.

*1: For details, refer to “Acceptable Input Signals” on page 63.

*2: Not all optional accessories are available in all countries and area. Please check with your local Sony Authorized Dealer.

*3: Information on accessories in this manual is current as of April 2019.

*4: For details on the optional accessories, refer to their operating instructions.

*5: The projection lenses compatible to the projection lens adapters are as follows.

Projection Lens Adapter	Projection Lens
PK-F60LA1	VPLL-Z1032
PK-F60LA2	VPLL-Z1024
PK-F60LA3	VPLL-Z2009
PK-F60LA4	VPLL-2007

Design and specifications of the unit, including the optional accessories, are subject to change without notice.

Pin assignment

DVI-D terminal (DVI-D, female)

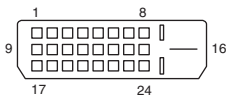

1	T.M.D.S. Data2-	14	+5 V Power
2	T.M.D.S. Data2+	15	Ground (return for +5 V)
3	T.M.D.S. Data2 Shield	16	Hot Plug Detect
4	NC	17	T.M.D.S. Data0-
5	NC	18	T.M.D.S. Data0+
6	DDC Clock	19	T.M.D.S. Data0 Shield
7	DDC Data	20	NC
8	NC	21	NC
9	T.M.D.S. Data1-	22	T.M.D.S. Clock Shield
10	T.M.D.S. Data1+	23	T.M.D.S. Clock+
11	T.M.D.S. Data1 Shield	24	T.M.D.S. Clock-
12	NC		
13	NC		

RGB input terminal (Mini D-sub 15-pin, female)

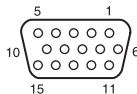

1	Video input (red) R	9	Power supply input for DDC
2	Video input (green) G	10	GND
3	Video input (blue) B	11	GND
4	GND	12	DDC/SDA
5	RESERVE	13	Horizontal sync signal
6	GND (R)	14	Vertical sync signal
7	GND (G)	15	DDC/SCL
8	GND (B)		

RS-232C terminal (D-Sub 9-pin, male)

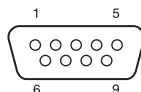

1	NC	6	NC
2	RXDA	7	RTS
3	TXDA	8	CTS
4	DTR	9	NC
5	GND		

HDMI terminal (HDMI, female)

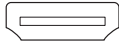

1	T.M.D.S. Data2+	11	T.M.D.S. Clock Shield
2	T.M.D.S. Data2 Shield	12	T.M.D.S. Clock-
3	T.M.D.S. Data2-	13	NC
4	T.M.D.S. Data1+	14	RESERVED (N.C.)
5	T.M.D.S. Data1 Shield	15	SCL
6	T.M.D.S. Data1-	16	SDA
7	T.M.D.S. Data0+	17	GND
8	T.M.D.S. Data0 Shield	18	+5V Power
9	T.M.D.S. Data0-	19	Hot Plug Detect
10	T.M.D.S. Clock+		

Acceptable Input Signals

Computer signal

Resolution	fH [kHz]/ fV [Hz]	Input terminal	
		INPUT A	INPUT B/ INPUT C/ INPUT D
640 × 350	31.5/70	●	–
	37.9/85	●	–
640 × 400	31.5/70	●	–
	37.9/85	●	–
640 × 480	31.5/60	●	●
	35.0/67	●	–
	37.9/73	●	–
	37.5/75	●	–
	43.3/85	●	–

Resolution	fH [kHz]/ fV [Hz]	Input terminal	
		INPUT A	INPUT B/ INPUT C/ INPUT D
800 × 600	35.2/56	●	–
	37.9/60	●	●
	48.1/72	●	–
	46.9/75	●	–
832 × 624	49.7/75	●	–
	53.7/85	●	–
1024 × 768	48.4/60	●	●
	56.5/70	●	–
	60.0/75	●	–
	68.7/85	●	–
1152 × 864	64.0/70	●	–
	67.5/75	●	–
	77.5/85	●	–
1152 × 900	61.8/66	●	–
1280 × 960	60.0/60	●	●
	75.0/75	●	–
1280 × 1024	64.0/60	●	●
	80.0/75	●	–
	91.1/85	●	–
1400 × 1050	65.3/60	●	●
1600 × 1200	75.0/60	●	●
1280 × 768	47.8/60	●	●
1280 × 720	45.0/60	●	● ^{*2}
1920 × 1080	67.5/60	–	● ^{*2}
1366 × 768	47.7/60	●	●
1440 × 900	55.9/60	●	●
1680 × 1050	65.3/60	●	●
1280 × 800	49.7/60	●	●
1920 × 1200	74.0/60	● ^{*1}	● ^{*1}
1600 × 900	60.0/60	● ^{*1}	● ^{*1}

Video signal

Signal	fV [Hz]	Input terminal		
		VIDEO	INPUT A	INPUT B/ INPUT C/ INPUT D
NTSC	60	●	–	–
PAL/ SECAM	50	●	–	–
480i	60	–	●	●
576i	50	–	●	●
480p	60	–	●	●
576p	50	–	●	●
1080i	60	–	●	●
1080i	50	–	●	●
720p	60	–	●	● ^{*2}
720p	50	–	●	●
1080p	60	–	–	● ^{*2}
1080p	50	–	–	●
1080p	24	–	–	●

Notes

- *1: Available for VESA Reduced Blanking signals only.
- *2: INPUT B is determined as a computer signal; INPUT C/INPUT D is determined as a video signal.
- When a signal other than the signals listed in table is input, the picture may not be displayed properly.
- An input signal meant for screen resolution different from that of the panel will not be displayed in its original resolution. Text and lines may be uneven.
- Some actual value may differ slightly from the design values given in the table.

Projection Distance and Lens Shift Range

The projection distance refers to the distance between the front of the lens and the projected surface.

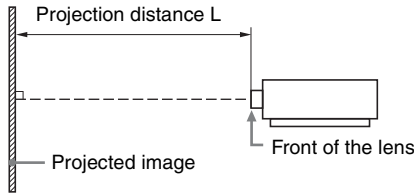

The lens shift range represents the distance in percent (%) by which the lens can be shifted from the center of the projected image. The lens shift range is regarded as 0% when the point (A) in the illustration (point where a line drawn from the center of the lens and the projected image cross at right angles) is aligned with the center of the projected image and full width or full height of the projected image is regarded as 100%.

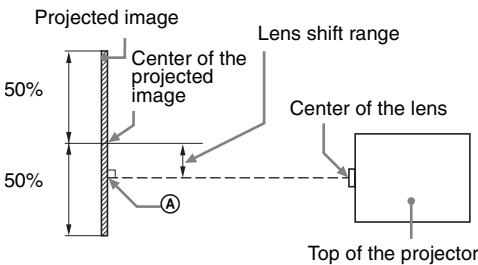
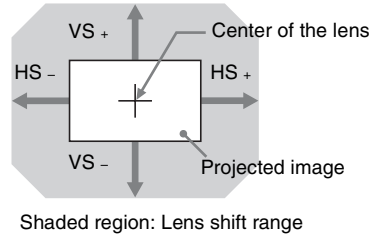
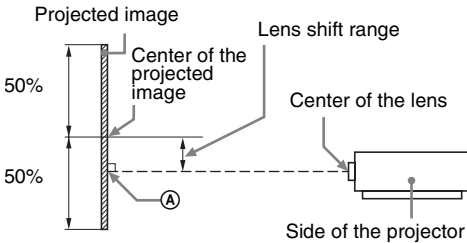

- VS +: Vertical lens shift range (up) [%]
- VS -: Vertical lens shift range (down) [%]
- HS +: Horizontal lens shift range (right) [%]
- HS -: Horizontal lens shift range (left) [%]

Projection distance

Unit: m (inches)

Projection image size		Projection distance L		
Diagonal	Width × Height	Standard lens	VPLL-3007	VPLL-Z3009
80" (2.03 m)	1.72 × 1.08 (68 × 42)	2.36 – 3.86 (93 – 152)	1.09 (43)	1.44 – 1.69 (57 – 66)
100" (2.54 m)	2.15 × 1.35 (85 × 53)	2.96 – 4.84 (117 – 191)	1.38 (54)	1.82 – 2.13 (72 – 84)
120" (3.05 m)	2.58 × 1.62 (102 × 64)	3.57 – 5.82 (141 – 229)	1.67 (66)	2.20 – 2.57 (87 – 101)
150" (3.81 m)	3.23 × 2.02 (127 × 79)	4.47 – 7.29 (176 – 287)	2.11 (83)	2.76 – 3.23 (109 – 127)
200" (5.08 m)	4.31 × 2.69 (170 × 106)	5.97 – 9.73 (235 – 383)	2.83 (112)	3.70 – 4.34 (146 – 170)

Projection image size	Projection distance L		
Diagonal	VPLL-Z3010	VPLL-Z3024	VPLL-Z3032
80" (2.03 m)	1.69 – 2.37 (67 – 93)	4.00 – 5.48 (158 – 215)	5.45 – 8.32 (215 – 327)
100" (2.54 m)	2.13 – 2.98 (84 – 117)	5.03 – 6.87 (198 – 270)	6.84 – 10.43 (270 – 410)
120" (3.05 m)	2.56 – 3.59 (101 – 141)	6.05 – 8.27 (238 – 325)	8.24 – 12.55 (325 – 494)
150" (3.81 m)	3.22 – 4.50 (127 – 177)	7.59 – 10.36 (299 – 408)	10.33 – 15.72 (407 – 619)
200" (5.08 m)	4.31 – 6.03 (170 – 237)	10.15 – 13.85 (400 – 545)	13.82 – 21.00 (544 – 827)

Projection distance formula

D: Projection image size (")

Example) Enter 80 in D for the 80" projection image size.

Unit: m (inches)

Lens	Projection distance L (minimal length)	Projection distance L (maximal length)
Standard lens	$L = 0.030040 \times D - 0.0443$ ($L = 1.182677 \times D - 1.7457$)	$L = 0.048910 \times D - 0.0442$ ($L = 1.925591 \times D - 1.7394$)
VPLL-3007	$L = 0.014518 \times D - 0.0700$ ($L = 0.571579 \times D - 2.7563$)	–
VPLL-Z3009	$L = 0.018832 \times D - 0.0678$ ($L = 0.741408 \times D - 2.6702$)	$L = 0.022017 \times D - 0.0635$ ($L = 0.866824 \times D - 2.4985$)
VPLL-Z3010	$L = 0.021850 \times D - 0.0631$ ($L = 0.860217 \times D - 2.4830$)	$L = 0.030491 \times D - 0.0640$ ($L = 1.200444 \times D - 2.5211$)
VPLL-Z3024	$L = 0.051187 \times D - 0.0973$ ($L = 2.015234 \times D - 3.8296$)	$L = 0.069717 \times D - 0.0930$ ($L = 2.744761 \times D - 3.6617$)
VPLL-Z3032	$L = 0.069792 \times D - 0.1414$ ($L = 2.747720 \times D - 5.5654$)	$L = 0.105707 \times D - 0.1323$ ($L = 4.161687 \times D - 5.2083$)

Lens shift range

■ Standard lens

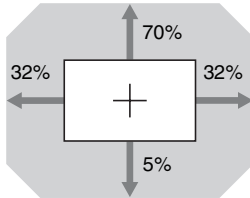

$$VS + = 70 - 2.187 \times (HS + \text{ or } HS -) [\%]$$

$$VS - = 5 - 0.156 \times (HS + \text{ or } HS -) [\%]$$

$$HS + = 32 - 0.457 \times VS + [\%]$$

$$HS - = 32 - 6.400 \times VS - [\%]$$

■ VPLL-Z3024, VPLL-Z3032

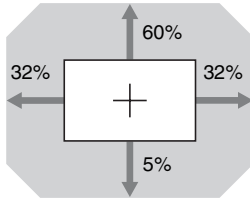

$$VS + = 60 - 1.875 \times (HS + \text{ or } HS -) [\%]$$

$$VS - = 5 - 0.156 \times (HS + \text{ or } HS -) [\%]$$

$$HS + = HS - = 32 - 0.533 \times VS + [\%]$$

$$HS + = HS - = 32 - 6.400 \times VS - [\%]$$

■ VPLL-3007

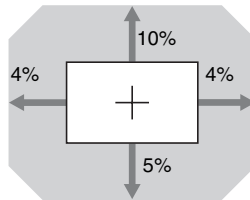

$$VS + = 10 - 2.500 \times (HS + \text{ or } HS -) [\%]$$

$$VS - = 5 - 1.250 \times (HS + \text{ or } HS -) [\%]$$

$$HS + = HS - = 4 - 0.400 \times VS + [\%]$$

$$HS + = HS - = 4 - 0.800 \times VS - [\%]$$

■ VPLL-Z3009

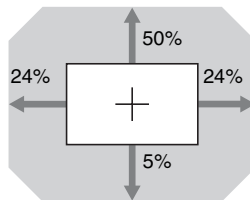

$$VS + = 50 - 2.083 \times (HS + \text{ or } HS -) [\%]$$

$$VS - = 5 - 0.208 \times (HS + \text{ or } HS -) [\%]$$

$$HS + = HS - = 24 - 0.480 \times VS + [\%]$$

$$HS + = HS - = 24 - 4.800 \times VS - [\%]$$

■ VPLL-Z3010

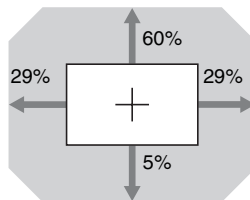

$$VS + = 60 - 2.069 \times (HS + \text{ or } HS -) [\%]$$

$$VS - = 5 - 0.172 \times (HS + \text{ or } HS -) [\%]$$

$$HS + = HS - = 29 - 0.483 \times VS + [\%]$$

$$HS + = HS - = 29 - 5.800 \times VS - [\%]$$

Dimensions

Front

Unit: mm (inches)

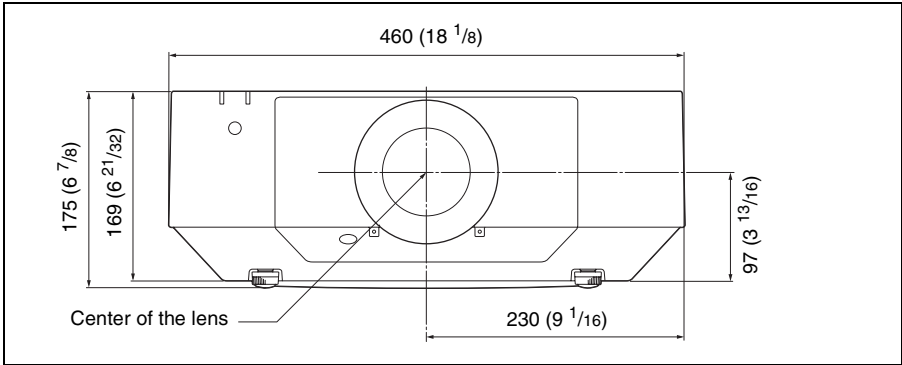

Bottom

Unit: mm (inches)

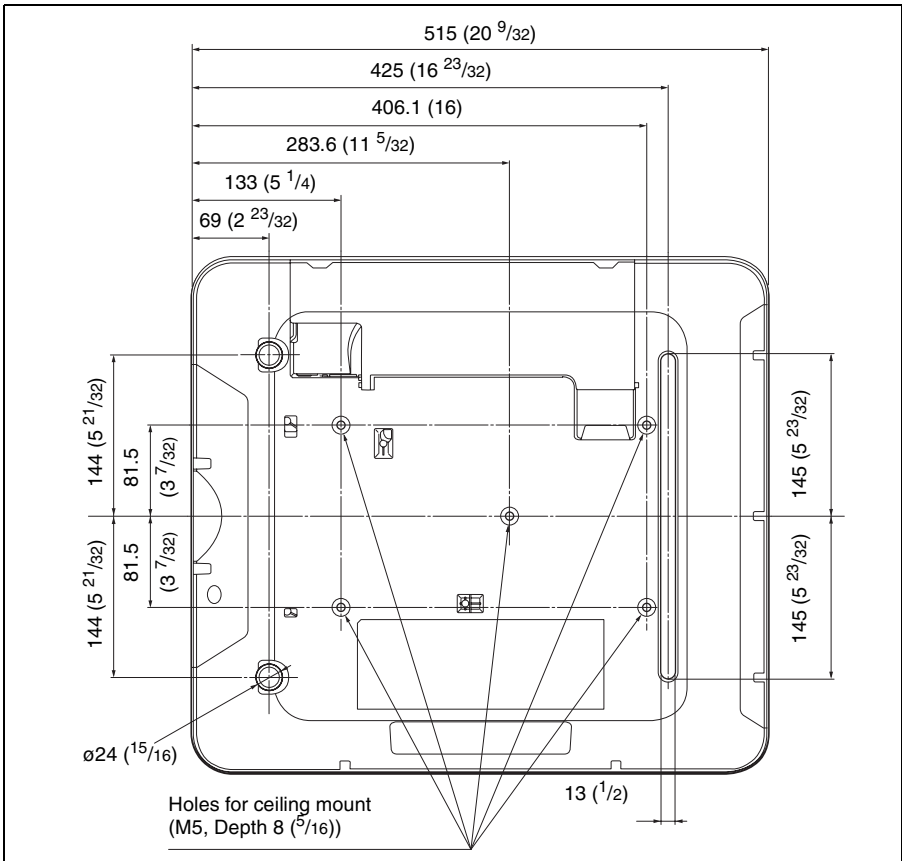

About Trademarks

- Adobe Acrobat is a trademark of Adobe Systems Incorporated.
- Kensington is a registered trademark of Kensington Technology Group.
- Internet Explorer is registered trademarks of Microsoft Corporation in the United States and/or other countries.
- Safari is a registered trademark of Apple Corporation in the United States and/or other countries.
- PJLink is a registered trademark of Japan Business Machine and Information System Industries Association.
- AMX is a trademark of AMX Corporation.
- The terms HDMI and HDMI High-Definition Multimedia Interface, and the HDMI Logo are trademarks or registered trademarks of HDMI Licensing Administrator, Inc. in the United States and other countries.
- Crestron RoomView is a trademark of Crestron Corporation.
- HDBaseT™ and the HDBaseT Alliance logo are trademarks of the HDBaseT Alliance.
- Extron and XTP Systems are trademarks of RGB Systems, Inc.
- All other trademarks and registered trademarks are trademarks or registered trademarks of their respective holders. In this manual, ™ and ® marks are not specified.

