



ST4302S/ST5502S/ST6502S

ST7502S/ST8602S

Digital Signage

User Manual



Disclaimer

BenQ Corporation makes no representations or warranties, either expressed or implied, with respect to the contents of this document. BenQ Corporation reserves the right to revise this publication and to make changes from time to time in the contents thereof without obligation to notify any person of such revision or changes.

Copyright

Copyright 2022 BenQ Corporation. All rights reserved. No part of this publication may be reproduced, transmitted, transcribed, stored in a retrieval system or translated into any language or computer language, in any form or by any means, electronic, mechanical, magnetic, optical, chemical, manual or otherwise, without the prior written permission of BenQ Corporation.

Product support

This document aims to provide the most updated and accurate information to customers, and thus all contents may be modified from time to time without prior notice. Please visit the website for the latest version of this document and other product information. Available files vary by model.

1. Make sure your computer is connected to the Internet.
2. Visit the local website from www.BenQ.com. The website layout and content may vary by region/country.
 - User manual and related document: www.BenQ.com > **Business** > **SUPPORT** > **Downloads** > model name > **User Manual**
 - (EU only) Dismantled information: Available on the user manual download page. This document is provided based on Regulation (EU) 2019/2021 to repair or recycle your product. Always contact the local customer service for servicing within the warranty period. If you wish to repair an out-of-warranty product, you are recommended to go to a qualified service personnel and obtain repair parts from BenQ to ensure compatibility. Do not disassemble the product unless you are aware of the consequences. If you cannot find the dismantled information on your product, contact the local customer service for assistance.

EPREL Registration Number:

ST4302S: 776755

ST5502S: 776770

ST6502S: 1120356

ST7502S: 1123870

ST8602S: 1123894

Table of Contents

Product support.....	iii
Safety warnings and precautions	1
Important safety instructions.....	2
Notes on the LCD panel of this display	2
Safety notice for remote control	3
Battery safety notice	3
BenQ ecoFACTS.....	4
Package contents	5
Setting up the display	6
Mounting the display	6
Parts of the display and their functions	9
Power status indicator	10
Control panel.....	10
Input/output terminals.....	11
Remote control.....	13
Using the remote control	14
Connection	15
Connecting audio/video signals	15
Connecting power	19
Basic operations.....	20
Turning the display on or off	20
Switching input source	20
Operations in the OSD menu	21
Initial setup	22
Settings	22
Setting up the Internet connection.....	23
Updating software	25
OSD menu operations	26
Picture	26

Screen	28
Audio	29
Configuration 1	30
Configuration 2	31
Advanced option	32
System interface.....	35
Main screen	35
APPS.....	37
Product information.....	52
Specifications.....	52
Dimensions.....	55
Supported input signal resolution	60
Troubleshooting	62

Safety warnings and precautions



The lightning flash with arrowhead symbol, within an equilateral triangle, is intended to alert the user to the presence of uninsulated “dangerous voltage” within the product’s enclosure that may be of sufficient magnitude to constitute a risk of electric shock to persons.



The exclamation point within an equilateral triangle is intended to alert the user to the presence of important operating and maintenance (servicing) instructions in the literature accompanying the appliance.

THIS EQUIPMENT MUST BE GROUNDED

To ensure safe operation, the three-pin plug must be inserted only into a standard three-pin power outlet which is effectively grounded through normal household wiring. Extension cords used with the equipment must have three cores and be correctly wired to provide connection to the ground. Wrongly wired extension cords are a major cause of fatalities.

The fact that the equipment operates satisfactorily does not imply that the power outlet is grounded or that the installation is completely safe. For your safety, if you are in any doubt about the effective grounding of the power outlet, please consult a qualified electrician.

- The mains plug of the power supply cord shall remain readily operable. The AC receptacle (mains socket outlet) shall be installed near the equipment and shall be easily accessible. To completely disconnect this equipment from the AC mains, disconnect the power cord plug from the AC receptacle.
- Do not place this display on an uneven, sloping or unstable surface (such as a trolley) where it may fall and cause damage to itself or others.
- Do not place this display near water, like a spa or pool, or in a position which will allow the splashing or spraying of water onto the display, like in front of an open window where rain water may enter.
- Do not install this display in a confined space without proper ventilation and air circulation, such as in a closed cabinet. Allow proper space around the display for dissipating heat inside. Do not block any openings and vents on the display. Overheating may result in hazards and electric shock.
- Installation of this display should only be performed by a qualified technician. Failure to install this display properly may cause injuries and damages to the personnels and the display itself. Check the installation regularly and maintain the display periodically to ensure the best working condition.
- Use only the accessories approved or recommended by the manufacturer to mount this display. Using wrong or unsuitable accessories may cause the display to fall and result in serious personal injuries. Make sure that the surface and fixing points are strong enough to sustain the weight of the display.
- To reduce the risk of electric shock, do not remove covers. No user serviceable parts inside. Refer servicing to qualified service personnel.
- To prevent personal injuries, mounting the display or installing desktop stands is required before use.

Important safety instructions

1. Read these instructions.
2. Keep these instructions.
3. Heed all warnings.
4. Follow all instructions.
5. Do not use this apparatus near water.
6. Clean only with dry cloth.
7. Do not block any ventilation openings. Install in accordance with the manufacturer's instructions.
8. Do not install near any heat sources such as radiators, heat registers, stoves, or other apparatus (including amplifiers) that produce heat.
9. Do not defeat the safety purpose of the polarized or grounding-type plug. A polarized plug has two blades with one wider than the other. A grounding-type plug has two blades and a third grounding prong. The wide blade or the third prong are provided for your safety. If the provided plug does not fit into your outlet, consult an electrician for replacement of the obsolete outlet.
10. Protect the power cord from being walked on or pinched particularly at plugs, convenience receptacles, and the point where they exit from the apparatus.
11. Only use attachments/accessories specified by the manufacturer.
12. Use only with the cart, stand, tripod, bracket, or table specified by the manufacturer, or sold with the apparatus. When a cart is used, use caution when moving the cart/apparatus combination to avoid injury from tip-over.
13. Unplug this apparatus during lightning storms or when unused for long periods of time.
14. Refer all servicing to qualified service personnel. Servicing is required when the apparatus has been damaged in any way, such as power-supply cord or plug is damaged, liquid has been spilled or objects have fallen into the apparatus, the apparatus has been exposed to rain or moisture, does not operate normally, or has been dropped.



Notes on the LCD panel of this display

- The Liquid Crystal Display (LCD) panel of this display has a very thin protective layer of glass which is liable to marking or scratching, and cracking if struck or pressured. The liquid crystal substrate is also liable to damage under excessive force or extreme temperatures. Please handle with care.
- The response time and brightness of the LCD panel may vary with the ambient temperature.
- Avoid placing the display in direct sun or where direct sun or spot lighting will shine onto the LCD panel, as the heat may damage the panel and the external casing of the display, and the bright light will make viewing the display more difficult than necessary.
- The LCD panel consists of individual pixels to display images and is manufactured according to the design specifications. While 99.9% of these pixels work normally, 0.01% of the pixels may remain constantly lit (in red, blue or green) or unlit. This is a technical limitation of the LCD technology and is not a defect.

- LCD screens, like plasma (PDP) and conventional CRT (Cathode Ray Tube) screens, are also susceptible to 'screen burn-in' or 'image retention' which can be found on the screen as visible fixed lines and shades. To avoid such damage to the screen, avoid displaying still images (like On-Screen Display menus, fixed/inactive text or icons) for more than 30 minutes. Change the aspect ratio from time to time. Fill the entire screen with the image and eliminate the black bars whenever possible. Avoid displaying images in 4:3 aspect ratio over a long period of time, otherwise there may be visible burn marks on the screen as two vertical lines.

Note: Under certain circumstances, condensation may occur on the inner side of the cover glass, it's a natural phenomenon and will not affect the operation of the display. This condensation will usually disappear after around 2 hours of normal operation.

- ST series does not offer image retention function, for more information, please refer to installation guide.
- For ST series, when the power goes out unexpectedly, please make sure the time zone is correctly synced via the Internet, otherwise manual adjustment is needed.

Safety notice for remote control

- Do not put the remote control in the direct heat, humidity, and avoid fire.
- Do not drop the remote control.
- Do not expose the remote control to water or moisture. Failure to do so could result in malfunction.
- Confirm there is no object between the remote control and the remote sensor of the product.
- When the remote control will not be used for an extended period, remove the batteries.

Battery safety notice

The use of the wrong type of batteries may cause chemical leaks or explosion. Please note the following:

- Always ensure that the batteries are inserted with the positive and negative terminals in the correct direction as shown in the battery compartment.
- Different types of batteries have different characteristics. Do not mix different types.
- Do not mix old and new batteries. Mixing old and new batteries will shorten battery life or cause chemical leaks from the old batteries.
- When batteries fail to function, replace them immediately.
- Chemicals which leak from batteries may cause skin irritation. If any chemical matter seeps out of the batteries, wipe it up immediately using a dry cloth, and replace the batteries as soon as possible.
- Due to varying storage conditions, the battery life for the batteries included with your product may be shortened. Replace them within 3 months or as soon as you can after initial use.
- There may be local restrictions on the disposal or recycling of batteries. Consult your local regulations or waste disposal provider.

BenQ ecoFACTS

BenQ has been dedicated to the design and development of greener product as part of its aspiration to realize the ideal of the “Bringing Enjoyment 'N Quality to Life” corporate vision with the ultimate goal to achieve a low-carbon society. Besides meeting international regulatory requirement and standards pertaining to environmental management, BenQ has spared no efforts in pushing our initiatives further to incorporate life cycle design in the aspects of material selection, manufacturing, packaging, transportation, using and disposal of the products. BenQ ecoFACTS label lists key eco-friendly design highlights of each product, hoping to ensure that consumers make informed green choices at purchase. Check out BenQ's CSR Website at <http://csr.BenQ.com/> for more details on BenQ's environmental commitments and achievements.



Package contents

Open the sales package and check the contents. If any item is missing or damaged, please contact your dealer immediately.



LCD display

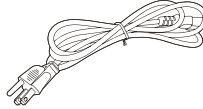

Power cord (By region)



Remote control

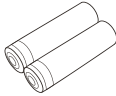

AAA battery x 2

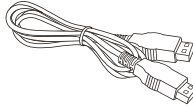

HDMI cable x 1

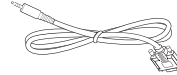

RS232 cable x 1



Quick start guide



- The type of power cord supplied may differ from that illustrated depending on your region of purchase.
- Before discarding the package, check that you haven't left any accessories inside the box.
- Dispose of packaging materials wisely. You can recycle the cardboard carton. Consider storing the package (if possible) for future transport of the display.
- Do not leave plastic bags within reach of young children or babies.

Setting up the display

Mounting the display

You can install the display on a vertical surface with a suitable wall mounting bracket or on a horizontal surface with the optional desktop stands. Please pay attention to the following notes during installation:

- This display should be installed by at least two adult persons. Attempting to install this display by only one person may result in danger and injuries.
- Refer the installation to qualified technicians. Improper installation may cause the display to fall or malfunction.

Installing the display on a wall

VESA Standard:

ST4302S: 200 x 200 (4 - M6 x 15L)

ST5502S: 400 x 400 (4 - M6 x 15L)

ST6502S: 400 x 400 (4 - M6 x 15L)

ST7502S: 600 x 400 (4 - M6 x 15L)

ST8602S: 600 x 400 (4 - M6 x 15L)

1. Place a clean, dry and lint-free cloth on a flat, horizontal and object-free surface. Make sure that the size of the cloth is larger than the display.
2. Gently lay the display on the cloth with the LCD screen facing down.
3. Remove the desktop stands from the display if installed.
4. Identify the wall mounting screw holes on the back of the display as shown in the illustration.

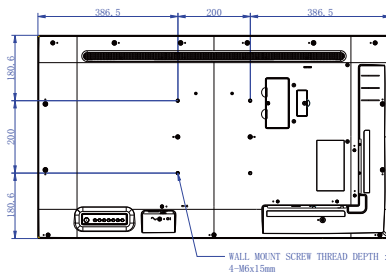

ST4302S

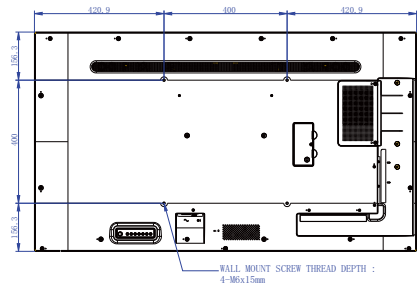

ST5502S

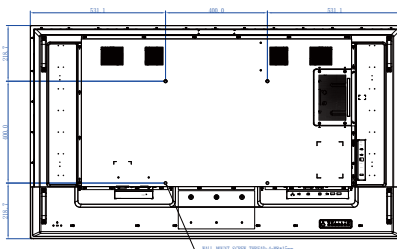

ST6502S

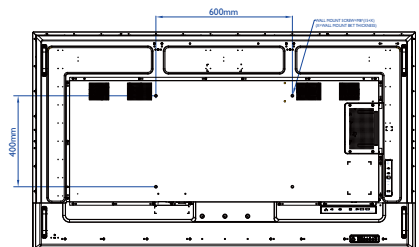

ST7502S

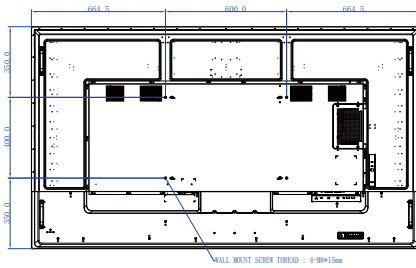

ST8602S

5. Install the wall mounting bracket on the display and attach the display to the wall according to the mounting bracket's instructions. The length of the screw should exceed the thickness of the wall mounting bracket, please refer to below chart for each model. Make sure that all screws are tightened and secured properly. (Recommended torque: 16 (+2/-2) kgf/cm). The mounting means should be strong enough to bear the weight of the display.

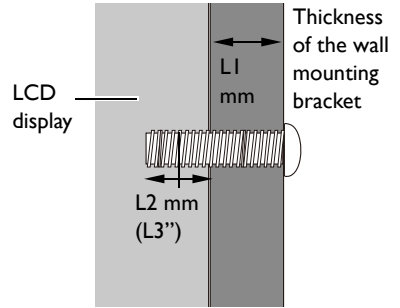

- To maintain proper ventilation, keep at least 10 mm of clear space from the back cover of the display to the wall.
- Please consult a professional technician for wall mount installations. The manufacturer accepts no liability for installations not performed by a professional technician.

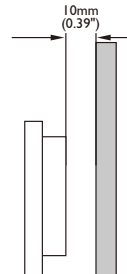

Mounting in portrait orientation (for ST4302S & ST5502S only)

This display can be installed in both landscape and portrait orientation.

When mounting the display in portrait orientation, rotate the display 90 degrees counter-clockwise as illustrated ensuring that the IR sensor of the display is orientated toward the top of the display.

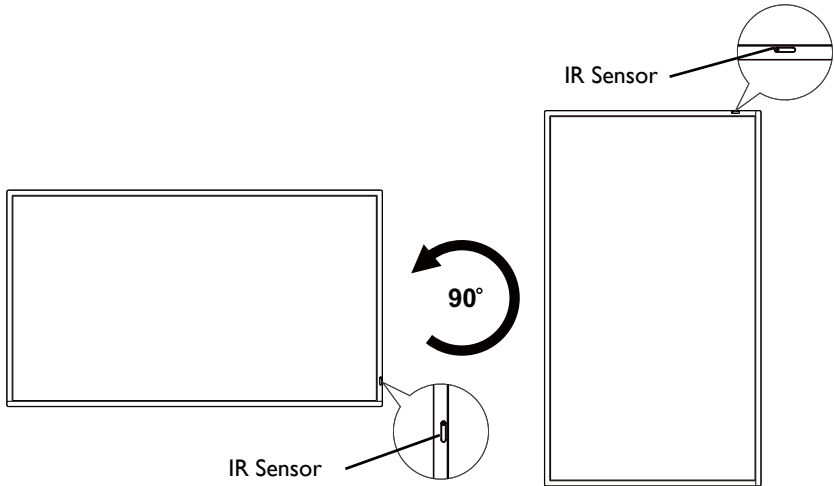

Parts of the display and their functions

ST4302S & ST5502S

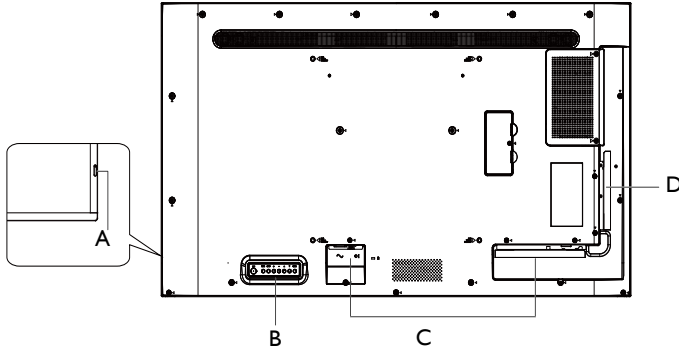

ST6502S & ST7502S & ST8602S

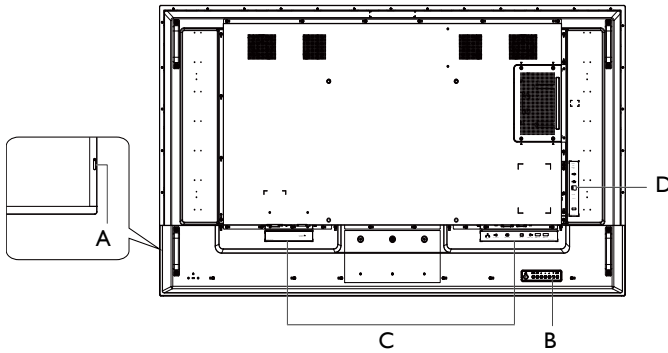

A	Remote Control Sensor & Power Status Indicator
B	Control panel
C	Input/output terminals: Bottom side
D	Input/output terminals: Left side

Power status indicator

Color	Status	Description
Green	On	The display is turned on.
Green and Red	Blink	The display is updating the firmware.
Red	On	The display is in standby mode.
Red	Blink	The display is receiving commands from the remote control.
Red	On	The display is in standby mode and Schedule has been enabled. Refer to Advanced option on page 32 for more information.
Green	Blink	
Off	Off	Power switch is turned off.

Control panel

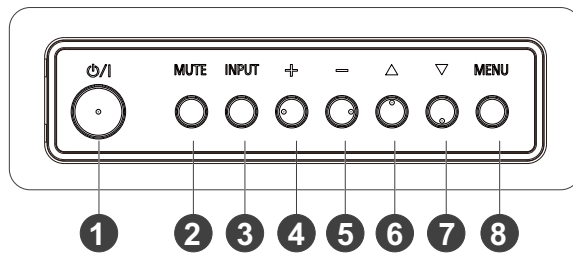

No.	Name	Description
1		Turns the display on/off.
2	MUTE	Disables the audio.
3	INPUT	Opens the input source menu.
4	+	<ul style="list-style-type: none"> Increases the volume. Opens the selected item or confirms a selection in the OSD or input source menu.
5	-	<ul style="list-style-type: none"> Decreases the volume. Returns to the previous page in the OSD or input source menu.
6	Δ	Scrolls up in the OSD or input source menu.
7	▽	Scrolls down in the OSD or input source menu.
8	MENU	Opens/closes the OSD menu.

Input/output terminals

Bottom side

ST4302S & ST5502S & ST6502S

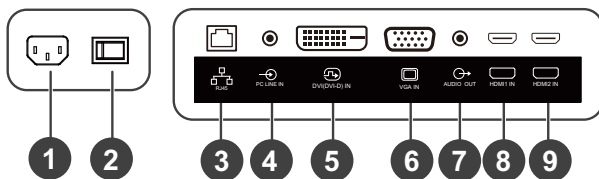

ST7502S & ST8602S

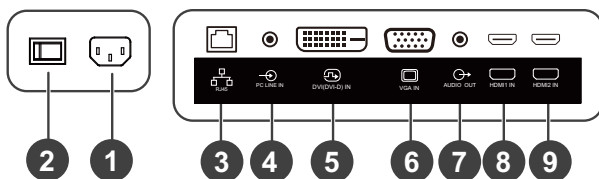

No.	Name	Description
1	AC IN Port	Connects to a power outlet through the supplied power cord.
2	Power Switch	Turns on/off the power supplied from the AC IN port.
3	RJ45	Connects with a local network using a standard Ethernet cable.
4	PC LINE IN	Connects with the VGA video source (via a 3.5mm cable) to receive audio from the device.
5	DVI (DVI-D) IN	Connects with devices transmitting video using the DVI-D interface.
6	VGA IN	Connects with devices transmitting video using the VGA interface.
7	AUDIO OUT	Connects with an external audio device (such as a speaker, stereo system, or headphone) to output the audio that is supplied by the video source.
8	HDMI1 IN	Connects with devices transmitting audio/video using the HDMI interface.
9	HDMI2 IN	

Left Side

ST4302S & ST5502S

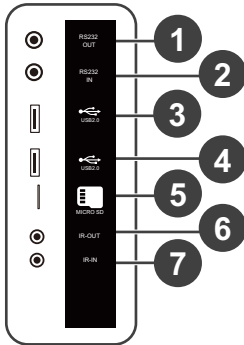

ST6502S & ST7502S & ST8602S

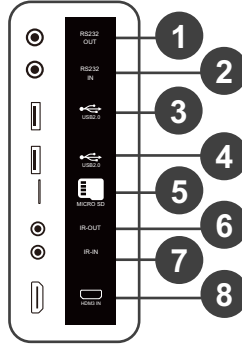

No.	Name	Description
1	RS232 OUT	Connects with the serial I/O input connector of a device to transfer data.
2	RS232 IN	Connects with the serial I/O output connector of a device to receive data.
3	USB2.0	Connects with a USB 2.0 flash drive to play media files stored on the drive.
4	USB2.0	
5	MICRO SD	Accepts microSD cards to play media files stored on the card.
6	IR-OUT	Connects with an external A/V device through an IR extension cable to transfer signals from the IR sensor.
7	IR-IN	Connects with an external IR receiver.
8	HDMI3 IN	Connects with devices transmitting audio/video using the HDMI interface.

Remote control

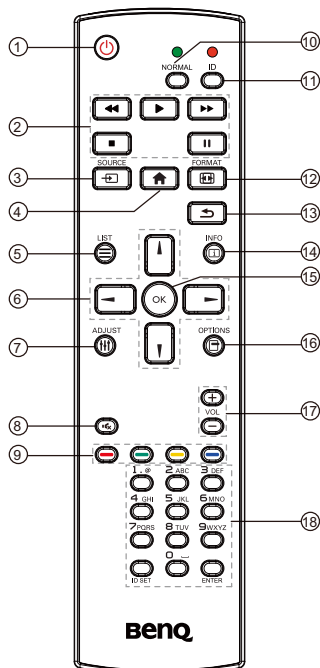

Turns the display on/off.



- Controls the playback of audio/video input from the external A/V devices via the VGA, DVI-D, and HDMI interface.
- Controls the playback of media files when using the **Media Player** app.



Opens the input source menu.



Returns to the home screen.



- Opens the OSD menu.
- Opens menu when using **X-Sign**.



• Navigates the OSD menu.

- Scrolls up/down/left/right when opening a web page.



No function.



Disables the audio.



- The red, green, and yellow buttons have no function.
- The blue button turns on/off the backlight of the display.



Returns to normal operation after setting display ID.



Sets display ID if you need to control several displays in a daisy chain.



Adjusts the zoom level.



Returns to the previous page in the OSD menu or apps.



- Indicates through which interface your media content is being played and displays the resolution.
- Displays the media file's information when using the **Media Player** app.



Confirms the selected item.



Opens the toolbar when using the **Media Player** app.



Increases or decreases the volume.



Enters numbers and text.

Using the remote control

Installing remote control batteries

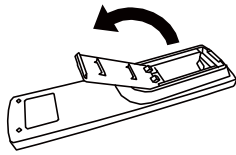

1. Press and flip open the battery compartment cover.

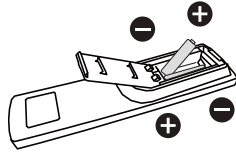

2. Insert two AAA batteries into the battery compartment ensuring that the (+) and (-) signs on the batteries match the (+) and (-) indications on the battery compartment.

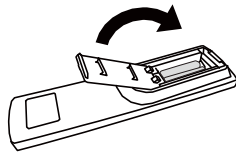

3. Flip and slide the cover over the battery compartment so the tab on the cover is inserted into the opening in the compartment.

Remote control usage tips

- When using the remote control, aim the remote control at the sensor at the display's bottom-right side within a distance of less than 5m, and a horizontal and vertical angle of less than 20 degrees.
- Do not let the remote control become wet or place it in humid environments (like bathrooms).
- If the display's remote control sensor window is exposed to direct sunlight or strong light, the remote control may not operate properly. In this situation, change the light source, readjust the angle of the display or operate the remote control from a location closer to the display's remote control sensor window.

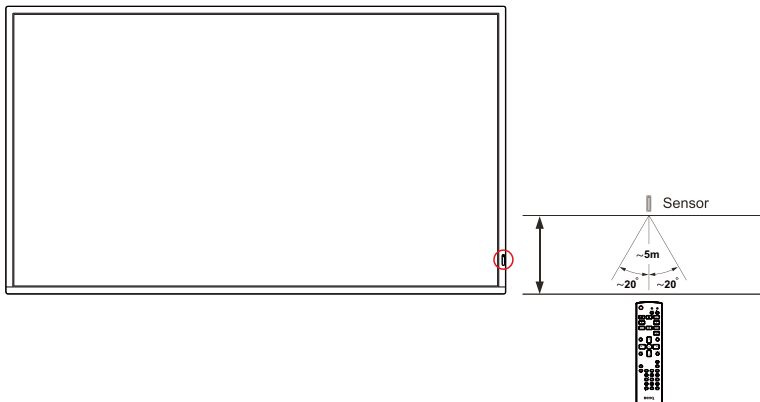

Connection

Connecting audio/video signals

Pay attention to the following notes when you connect cables:

- Please turn off all devices.
- Familiarize yourself with the audio/video ports on the display and the devices you want to use. Be aware that incorrect connections may adversely affect picture quality.
- Do not remove cables from the ports by pulling the cable itself. Always grasp and pull the connectors at the end of the cable.
- Ensure that all cables are fully inserted and firmly seated.

Connecting the digital inputs

To use the DVI interface:

1. Connect the **DVI (DVI-D) IN** jack on the display to the DVI output jack on a computer using a DVI-D cable.
2. Connect the computer's audio output jack to the **PC LINE IN** jack on the display using a suitable audio cable.
3. Press **INPUT** and then select **DVI-D** from the input source menu.

To use the HDMI interface:

1. Connect the HDMI output jack of a computer or A/V device (such as a VCR or DVD player) to the **HDMI1 IN** or **HDMI2 IN** jack on the display using an HDMI cable.
2. Press **INPUT** and then select **HDMI1** or **HDMI2** from the input source menu.

ST4302S & ST5502S:

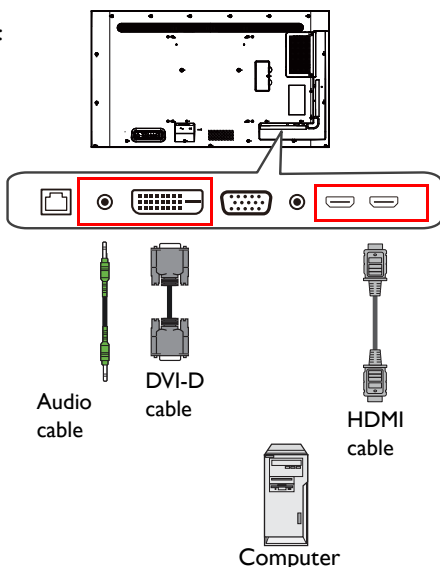

ST6502S & ST7502S & ST8602S:

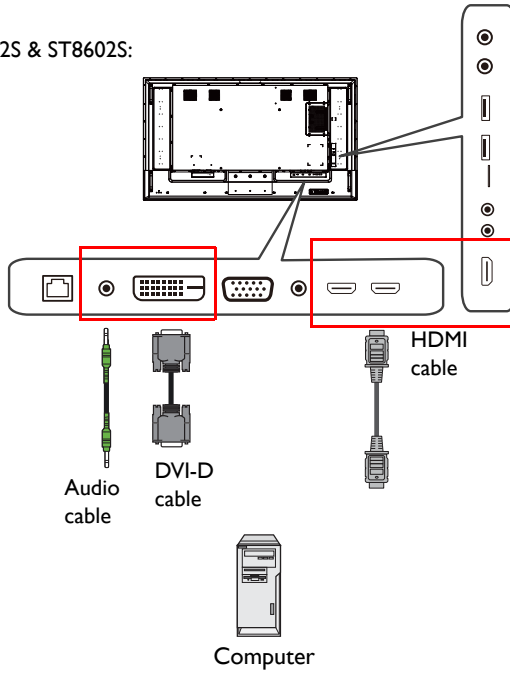

Connecting the analog input

1. Connect the **VGA IN** jack on the display to the VGA output jack on a computer using a D-Sub (15-pin) cable.
2. Connect the computer's audio output jack to the **PC LINE IN** jack on the display using a suitable audio cable.
3. Press **INPUT** and then select **VGA** from the input source menu.

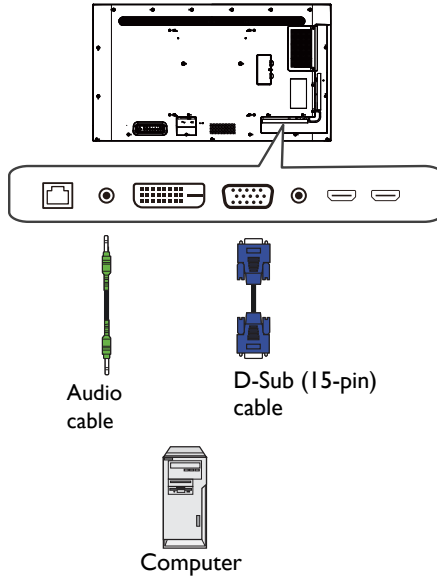

Connecting the multimedia inputs

To play multimedia files stored on the USB flash drive, insert the USB flash drive into the **USB2.0** port.

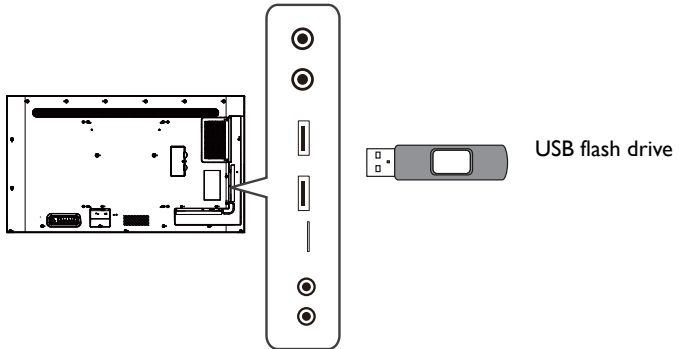

USB 2.0 standard spec is 0.5A and USB 3.0 standard spec is 0.9A.

Connecting power

Plug one end of the power cord into the power jack on the display and the other end into an appropriate power outlet (if the outlet is switched, turn on the switch).

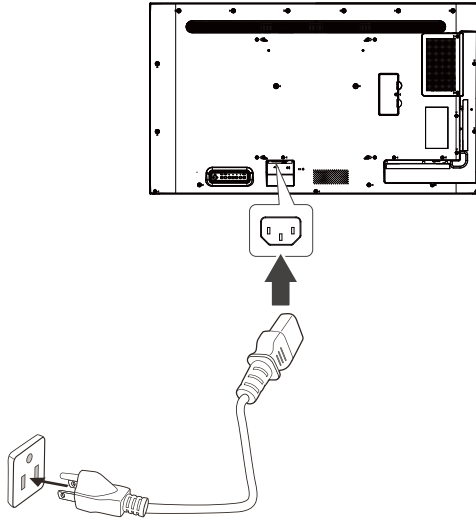

- The supplied power cord is suitable for use with 100-240V AC power only.
- The power cord and outlet illustrated may differ from the ones used in your region.
- Only use an appropriate power cord for your region. Never use a power cord which appears damaged or frayed, or change the plug type on the power cord.
- Be aware of the power loading when you use extension cords or multiple outlet power boards.
- There are no user serviceable parts in this display. Never unscrew or remove any covers.
- Turn off the power and unplug the power cord if you intend to move the display.

Basic operations

Turning the display on or off

1. Be sure to follow the instruction in [Connecting power on page 19](#).
2. Before turning on the display, make sure the power switch is set to ON. The system will enter standby mode.

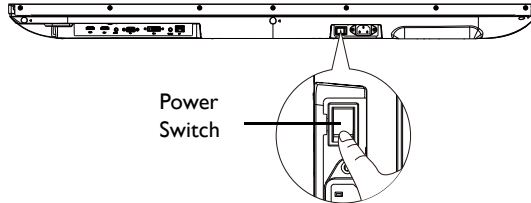

The display's standby mode still consumes power. To completely cut off power supply, set the Power switch to OFF and then disconnect the power cord from the power outlet.

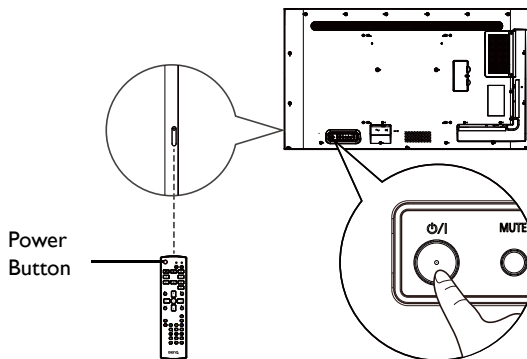







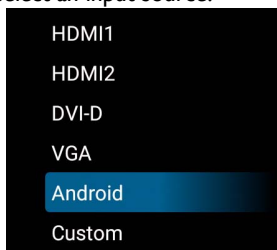

- Only when the power switch is set to on, the power button on the rear panel and the power button on the remote control will work.
- To turn on or off the display, press the power button on the rear panel or power button on the remote control.
- Display in standby mode still consumes power. To completely cut off the power supply, remove the power cord from the AC power outlet.

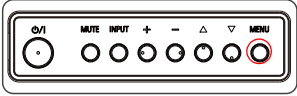
Switching input source

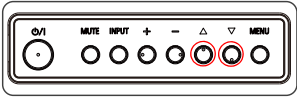
Press **INPUT** on the rear of the display or press  on the remote control to open the input source menu and then select an input source.

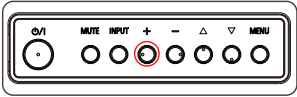

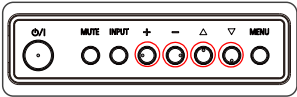
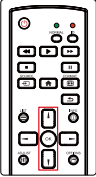
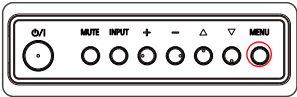
Operations in the OSD menu

Using the control panel buttons	Using the remote control
<p>1. Press MENU to open the OSD menu.</p> 	<p>1. Press ≡ to open the OSD menu.</p> 
<p>2. In the OSD menu, press △ or ▽ to scroll up or down.</p> 	<p>2. Press ▲ or ▼ to scroll up or down.</p> 
<p>3. Press + to confirm selections.</p> 	<p>3. Press OK to confirm selections.</p> 
<p>4. Press △ or ▽ to adjust settings and press + to confirm changes. Press ← to return to the previous page.</p> 	<p>4. Press ▲ and ▼ to adjust settings and press OK to confirm changes. Press ↶ to return to the previous page.</p> 
<p>5. Press MENU to close the OSD menu.</p> 	<p>5. Press ↶ to close the OSD menu.</p> 

Initial setup

After you have connected the display to the power, you are ready to power on the display. The first time you power on the display, you will be guided through a series of setup screens. Follow the on-screen instructions or the steps below to start up your display and complete the initial setup.

1. Turn on the display. Wait for the display to boot up with the BenQ screen. This may take a moment.
2. Select **Next** on the screen to begin. Follow the on-screen instructions to set up the language, date and time, and network. Or you can skip some of these steps and complete the setup later.

Settings

After booting up the display, the main screen will appear on the display.

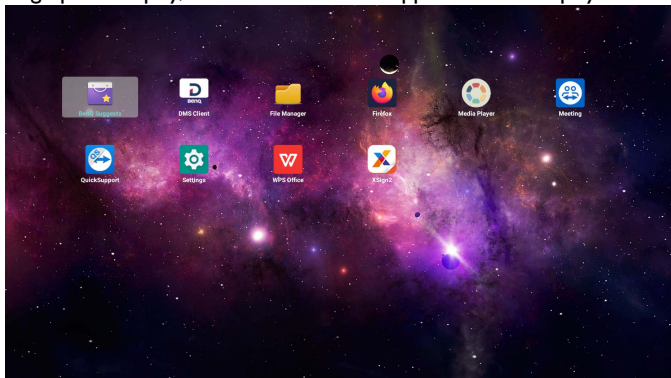

To configure the display, press **≡** on the remote control or **MENU** on the rear panel of the display to open the OSD menu.

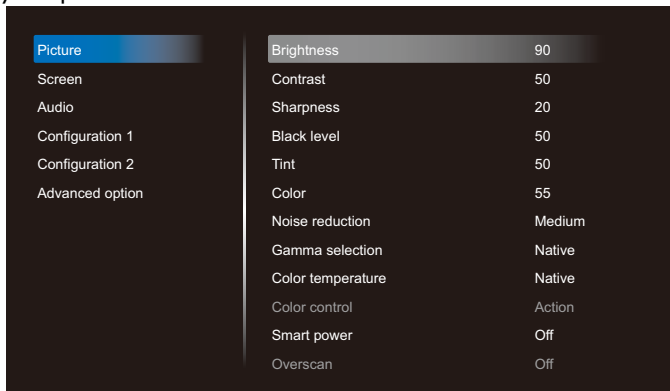

Refer to [OSD menu operations on page 26](#) for more information.



- If it is the first time to power on the display, the main screen will appear after the boot on process is finished.
- If **Boot on source** is set to any video input sources via the **DVI (DVI-D) IN**, **VGA IN**, **HDMI1 IN**, **HDMI2 IN** or **HDMI3 IN** port, the main screen will not appear after the display is turned on. You can press **↵** on the remote control and then select **Android** to open the main screen.

Setting up the Internet connection

Your display must be connected to a network to conduct OTA updates or surf the Internet.



To find the MAC address in operating system of the display, please go to **Settings > System > About > Status**.

Network setting

Follow the steps below to configure the wired network settings for the display.

1. Connect the display to a local network via an RJ45 cable.
2. On the main screen, select **Settings**.

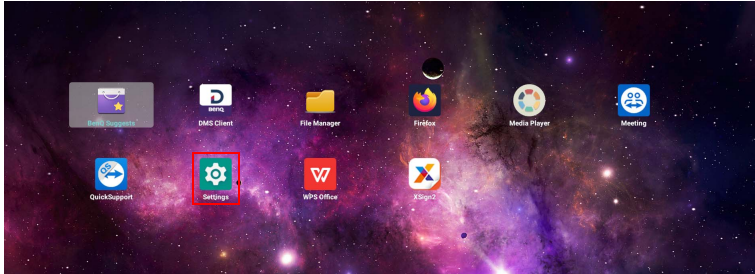

3. Go to **Network & Internet > Ethernet**.

- If you are in a DHCP environment, enable **Ethernet** and the display will be connected to the Internet automatically.

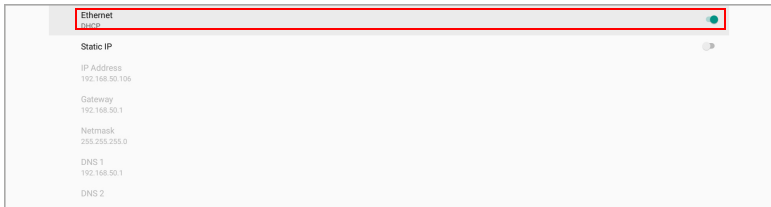

- If you are in a non-DHCP environment, enable **Static IP** and then manually set the IP Address, Gateway, Netmask, DNS 1 and DNS 2.



Wireless connection

You need to install a wireless adapter in order to connect the display to the Internet wirelessly. Please contact your local dealer for more information about the wireless adapter.

1. Install a wireless adapter to the display.
2. On the main screen, select **Settings**.

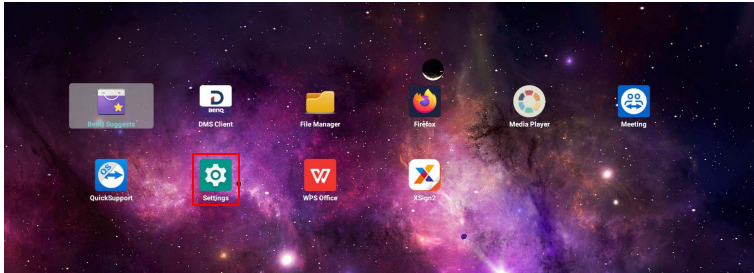

3. Go to **Network & Internet > Wi-Fi**.

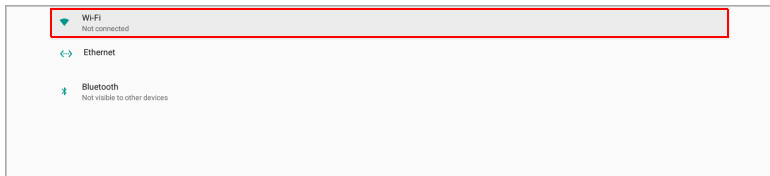

4. Enable **Wi-Fi**. The available networks will appear on the screen.
5. Select the wireless network you want to connect to.
6. Follow the on-screen instructions to input the password and connect the display to the wireless network.

Updating software

Whenever a new version of software is available, the system will automatically detect the update and will prompt you to download it every time you turn on the display.

To manually update the software:

On the main screen, go to **Settings > System > About > BenQ System Updates**.

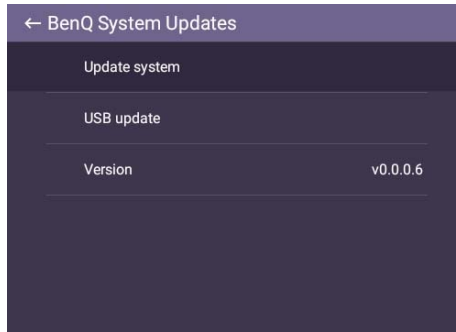

- Update system: The device will search for the update file while connecting to the Internet.
- USB update:
 - Copy the update file to the root of a FAT32 format USB drive. Make sure the file name is "update_signed.zip".
 - Insert the USB to the display, and the system will prompt a message for confirmation. If the message does not show up, select **USB Update** to start update detection.
 - Select **Start Update** to initiate update process.





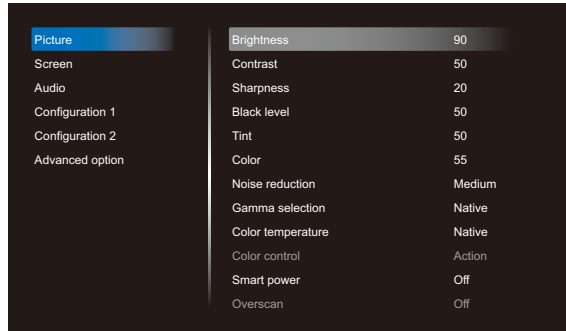

- Software update process may take some time to complete.
- During the update process, do not turn off the device or disconnect the Internet connection. Any interruptions during the software update process may permanently damage your display.

OSD menu operations

Picture



Menu	Description
Brightness	Adjusts the brightness of the display (0 to 100).
Contrast	Adjusts the contrast of the display (0 to 100).
Sharpness	Adjusts the sharpness of the display (0 to 100).  This option is not available for the input via the DVI (DVI-D) IN and VGA IN port.
Black level	Adjusts the brightness for the black portions of an image (0 to 100).
Tint	Adjusts the tint of the display (0 to 100).  This option is not available for the input via the DVI (DVI-D) IN and VGA IN port.
Color	Adjusts the saturation of the display (0 to 100).  This option is not available for the input via the DVI IN and VGA IN port.
Noise reduction	Reduces electrical image noise caused by different media players (Off / Low / Medium / High).  This option is not available for the input via the DVI IN and VGA IN port.
Gamma selection	Adjusts the mid-tone contrast of the display (Native / 2.2 / 2.4 / s gamma / D-image).
Color temperature	Adjusts the color temperature of the display (3000K / 4000K / 5000K / 6500K / 7500K / 9300K / 10000K / Native / User 1 / User 2). <ul style="list-style-type: none"> • Native: Default temperature. • User 1: Adjust the balance of each RGB color. • User 2: Adjust color temperature from 2000K to 10000K in step of 100K.

Menu	Description
Color control	Select Color temperature > User 1 to activate Color control . You can adjust individual red, green, and blue color balance. <ul style="list-style-type: none">• R (0 to 255)• G (0 to 255)• B (0 to 255)
Smart power	Adjusts the power consumption based on the brightness of the display automatically. <ul style="list-style-type: none">• Off: No adjustment.• Medium: 80% of power consumption relative to the brightness.• High: 65% of power consumption relative to the brightness.
Overscan	Enlarges the image displayed on the screen (Off / On).
Picture reset	Resets all settings in Picture menu to factory settings (CANCEL / Reset).

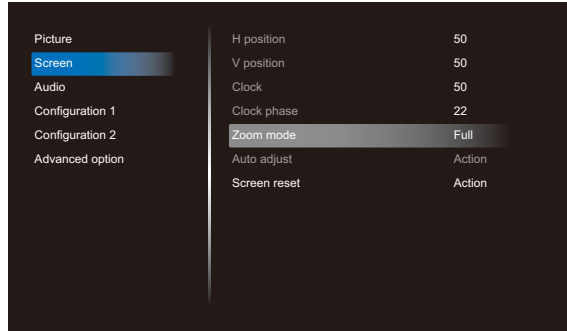

Screen



Menu	Description
H position	Adjusts the horizontal position of the video from the VGA IN input source (0 to 100).
V position	Adjusts the vertical position of the video from the VGA IN input source (0 to 100).
Clock	Adjusts the width of the video from the VGA IN input source (0 to 100).
Clock phase	Adjusts the clarity of the video from the VGA IN input source (0 to 100).
Zoom mode	Sets the zoom level (Full / 4:3 / Real).
Auto adjust	Enables Auto adjust to optimize the video from the VGA IN input source (CANCEL / OK).
Screen reset	Resets all settings in the Screen menu to factory settings (CANCEL / Reset).



Audio

Picture	Balance	50
Screen	Treble	50
Audio	Bass	50
Configuration 1	Volume	30
Configuration 2	Audio Out (Line Out)	30
Advanced option	Maximum Volume	100
	Minimum Volume	0
	Mute	Off
	Audio source	Digital
	Audio reset	Action
	Audio Out Sync	Off
	Speaker Setting	Off

Menu	Description
Balance	Adjusts the sound balance of the audio output (0 to 100).
Treble	Adjusts the treble of the audio output (0 to 100).
Bass	Adjusts the bass of the audio output (0 to 100).
Volume	Adjusts the volume of the audio output (0 to 100).
Audio Out (Line Out)	Adjusts the volume of the external speakers connected to the AUDIO OUT port of the display (0 to 100).  Audio Out (Line Out) will be disabled when Audio Out Sync is turned on.
Maximum Volume	Sets the maximum volume limit of the audio output (0 to 100).
Minimum Volume	Sets the minimum volume limit of the audio output (0 to 100).
Mute	Disables the audio output (Off / On).
Audio source	Selects the audio input signal type. <ul style="list-style-type: none"> • Analog: Select Analog if your computer or external A/V device is connected to the VGA IN port of the display. • Digital: Select Digital if your computer or external A/V device is connected to the DVI (DVI-D) IN, HDMI1 IN, HDMI2 IN or HDMI3 IN port of the display.
Audio reset	Resets all settings in Audio menu to factory settings (CANCEL / Reset).
Audio Out Sync	Synchronizes the volume of the internal speakers with the volume of the external A/V device or speaker connected to the display's AUDIO OUT port (Off / On).  When Audio Out Sync is enabled, Audio Out (Line Out) will be grayed-out.
Speaker Setting	Turns the internal speakers on/off (Off / On).

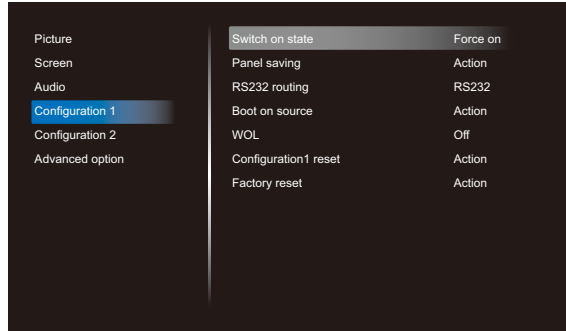
Configuration 1



Menu	Description
Switch on state	Sets the power-on status of the display (Power off / Forced on / Last status).
Panel saving	<p>Reduces the image persistence or image burn-in.</p> <ul style="list-style-type: none"> • Brightness: If enabled, the brightness of the display will be automatically adjusted to an appropriate level (Off / On). <p> If enabled, the Brightness setting in the Picture menu will be locked.</p> <ul style="list-style-type: none"> • Pixel Shift: Shifts the image shown on the screen after a specified period of time to prevent image persistence of the display (Auto / 10 to 900 seconds / Off). <p> Activating Pixel Shift will disable H position, V position, and Zoom mode in the Screen menu.</p>
RS232 routing	<p>Sets the RS232 routing path .</p> <ul style="list-style-type: none"> • RS232: RS232 commands are transmitted via the RS232 IN and RS232 OUT port. • LAN → RS232: RS232 commands are transmitted via the RJ45 port.
Boot on source	<p>Sets the input source that the display automatically opens to when powered on.</p> <ul style="list-style-type: none"> • Input: Sets the input source when booting up. • Playlist: Selects playlist when booting up.
WOL	Allows the display to be turned on by a network message (Off / On).
Configuration 1 reset	Resets all settings in the Configuration 1 menu to factory settings (CANCEL / Reset).
Factory reset	Resets all custom settings on the display to factory settings (CANCEL / Reset).

Configuration 2

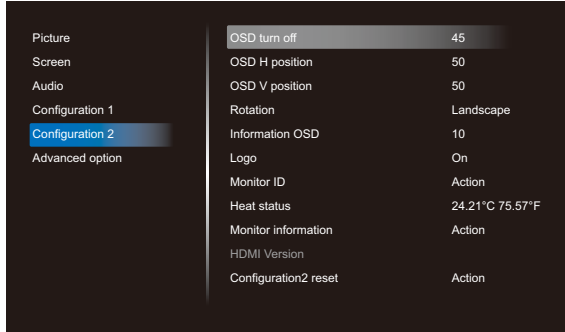

Menu	Description
OSD turn off	Sets the number of seconds the OSD menu is displayed before it automatically closes (Off / 5 to 120 seconds).
OSD H position	Adjusts the horizontal position of the OSD menu (0 to 100).
OSD V position	Adjusts the vertical position of the OSD menu (0 to 100).
Rotation	Sets the orientation of the OSD menu (Landscape / Portrait).  Only ST4302S & ST5502S support portait orientation.
Information OSD	Sets the number of seconds the information window is displayed before it automatically closes. The information window will appear on the screen when you change the input source (Off / 1 to 60 seconds).
Logo	Turns on/off the boot on logo of the display (Off / On / User).
Monitor ID	Gives a unique ID to a display or creates a group of displays so that you can control the display via the RS232 connection. <ul style="list-style-type: none"> • Monitor ID: 1 to 255. • Monitor group: 1 to 254.
Heat status	Indicates the temperature inside the display.
Monitor information	Lists the display's model name, serial number, operating hours, and the current software version.
HDMI Version	Sets the HDMI version (1.4 / 2.0).
Configuration 2 reset	Resets all settings in the Configuration 2 menu to factory settings (CANCEL / Reset).

Advanced option

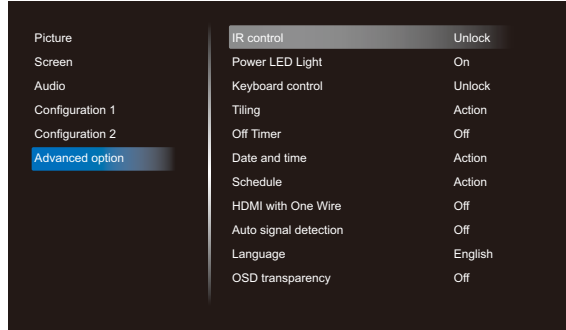

Menu	Description
IR control	<p>Allows you to control several displays simultaneously using one remote control when the displays are daisy chained together via the RS232 IN and RS232 OUT port.</p> <ul style="list-style-type: none"> • Unlock: Allows you to control the displays. • Lock All: Locks the displays. • Lock All but Volume: Only allows you to adjust the volume of the displays. • Lock All but Power: Only allows you to turn on/off the displays. • Lock All except PWR & VOL: Only allows you to turn on/off the displays and adjust the volume of the displays. • Primary: Designates a display as the primary display. Only the primary display will receive the commands from the remote control. • Secondary: Designates a display as the secondary display. The secondary display will not accept any commands from the remote control but the RS232 commands from the primary display. <p> To unlock, press and hold INFO on the remote control for 6 seconds.</p>
Power LED Light	Turns the power status LED on/off (On / Off).

Menu	Description
Keyboard control	Locks/Unlocks the buttons on the rear panel of the display. <ul style="list-style-type: none"> • Unlock: Unlocks the buttons. • Lock All: Locks the buttons. • Lock All but Volume: Only allows you to adjust the volume of the display. • Lock All but Power: Only allows you to turn on/off the display. • Lock All except PWR & VOL: Only allows you to turn on/off the display and adjust the volume of the display.
Tiling	Allows you to create a video wall that consists of up to 150 displays.  This option is accessible only when the input source is set to VGA IN, DVI IN, HDMI IN or OPS . <ul style="list-style-type: none"> • Switch on Delay: Sets the power-on-delay time (Off / Auto / 2 to 255 seconds). • Brightness: Adjusts the brightness of the displays of a video wall (Normal / ACS). • H monitors: Sets how many columns of display there are for the video wall (1 to 15). • V monitors: Sets how many rows of display there are for the video wall (1 to 10). • Position: Sets the display position in the video wall. • Frame comp.: Removes a small amount of graphical data for each display so that all displays can operate as one large canvas to display video content (Off / On). • Enable: Check to enable the tiling function.
Off timer	Allows the display to automatically turn off after a specified number of hours (Off / 1 to 24 hours).
Date and time	<ul style="list-style-type: none"> • Auto Sync: Allows the display to synchronize the date and time with the NTP (Network Time Protocol) server (On / Off). • Set date: Sets the date for the display. • Set time: Sets the time for the display. • Choose time zone: Sets the time zone for the display. • NTP Server: Displays the NTP server address. • Current date and time: Displays the current date and time of the display.

Menu	Description																			
Schedule	<p>Allows the display to automatically turn on/off at a pre-configured time.</p> <ul style="list-style-type: none"> • Schedule list: Allows users to create up to 7 schedules (1 to 7). • Enable: Check to enable the schedule. • Start time: Sets the time to turn on the display. • End time: Sets the time to turn off the display. • Input: Sets the input source that the display automatically opens when powered on (VGA IN / DVI IN / HDMI1 IN / HDMI2 IN / HDMI3 IN). • Playlist: Allows users to create up to 7 playlists for the media player (1 to 7). • Days of the week: Sets the day(s) of the week to execute the configuration of the schedule. • Back: Leaves the menu discarding the changes. • SAVE: Saves the changes. 																			
HDMI with One Wire	Enables/Disables the HDMI CEC function (Off / On).																			
Auto signal detection	Detects the input source automatically (Off / All / Failover). If several input sources are connected simultaneously, the detection priority is HDMI1 IN, HDMI2 IN, HDMI3 IN and DVI (DVI-D) IN .																			
Language	Sets the language of the OSD menu.																			
OSD transparency	Adjusts OSD transparency (Off / 1 to 100).																			
Power Save	<p>Sets the display to enter the power saving mode when there is no signal detected.</p> <table border="1" data-bbox="420 1008 1020 1401"> <thead> <tr> <th></th> <th>Power on/off behavior</th> <th>No input signal behavior (5 minutes count down)</th> <th>Input source signal recovery behavior</th> </tr> </thead> <tbody> <tr> <td>Mode 1</td> <td>Power off: DC off Power on: DC on</td> <td>Power off</td> <td>No action</td> </tr> <tr> <td>Mode 2</td> <td></td> <td></td> <td rowspan="2">Display will wake up only when the same input source recovers.</td> </tr> <tr> <td>Mode 3</td> <td>Power off: Backlight off; apps off; system keeps on.</td> <td>Backlight off</td> </tr> <tr> <td>Mode 4</td> <td>Power on: Backlight on; system boots up automatically. If boot logo is set to off, system will turn on the backlight without rebooting.</td> <td>Always on</td> <td>N/A</td> </tr> </tbody> </table>		Power on/off behavior	No input signal behavior (5 minutes count down)	Input source signal recovery behavior	Mode 1	Power off: DC off Power on: DC on	Power off	No action	Mode 2			Display will wake up only when the same input source recovers.	Mode 3	Power off: Backlight off; apps off; system keeps on.	Backlight off	Mode 4	Power on: Backlight on; system boots up automatically. If boot logo is set to off, system will turn on the backlight without rebooting.	Always on	N/A
	Power on/off behavior	No input signal behavior (5 minutes count down)	Input source signal recovery behavior																	
Mode 1	Power off: DC off Power on: DC on	Power off	No action																	
Mode 2			Display will wake up only when the same input source recovers.																	
Mode 3	Power off: Backlight off; apps off; system keeps on.	Backlight off																		
Mode 4	Power on: Backlight on; system boots up automatically. If boot logo is set to off, system will turn on the backlight without rebooting.	Always on	N/A																	
Advanced option reset	Resets all settings in the Advanced option menu to the default settings (CANCEL / Reset).																			



System interface

 Note that this is a closed platform. The closed platform ensures the proper use of the display by preventing downloads and use of unauthorized apps.



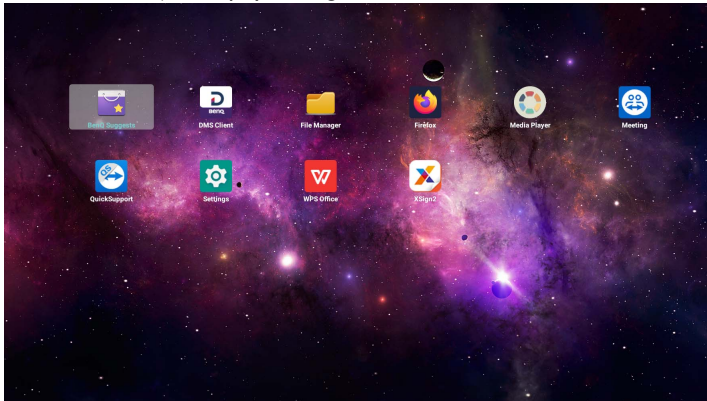

Main screen







Main screen of the display allows you to use BenQ’s various proprietary applications to create, manage, play captivating digital signage content to instantaneously engage your customers, as well as adjust display settings.



-  If it is the first time to power on the display, the main screen will appear after the boot on process is finished.
- If **Boot on source** is set to any video input sources via the **DVI (DVI-D) IN**, **VGA IN**, **HDMI1 IN**, **HDMI2 IN**, or **HDMI3 IN** port, the main screen may not appear after the display is turned on. You can press  on the remote control and then select **Android** to open the main screen.

The following apps can be accessed from the main screen:

Application Name	Description
X-Sign 	Serves as a digital signage content management system that provides multiple templates and remote scheduling through the Internet. Refer to X-Sign on page 37 for more information.
File Manager 	Manages your photos, music, or video files.
Media Player 	Allows you to view your photos or play the audio or video files. Refer to Media Player on page 44 for more information.
DMS Client 	Allows remote management, configuration, and monitoring of the display.
InstaShare 	Allows screen mirroring and touch control for collaborative meetings. InstaShare is not pre-installed. You need to download InstaShare via BenQ Suggests . Refer to InstaShare on page 38 for more information.

Application Name	Description
BenQ Suggests 	Allows you to download recommended apps. Refer to BenQ Suggests on page 40 for more information.
X-Sign Broadcast 	Serves as a wireless broadcast system that allows immediate message delivery as well as group notification.
TeamViewer Meeting 	Gives you access to instant or scheduled group meetings with any other TeamViewer Meeting users.
Firefox 	Allows you to view websites.
WPS Office 	Allows you to read PDF files or edit files created in Microsoft Office, PowerPoint, or Excel. Refer to WPS Office on page 41 for more information.
TeamViewer QuickSupport 	Allows technicians to provide remote technical assistance.
Settings 	Allows you to manage network and other device settings.

APPS

X-Sign

X-Sign is a digital signage content creation app. Users can create content with X-Sign Designer on their PCs or laptops and then import the file to the display through the USB flash drive. The content will be played automatically.



X-Sign Designer can be downloaded from BenQ website. Please refer to the postcard in the accessory pack for the download instructions.

InstaShare



InstaShare allows you to mirror the display's screen on your mobile device for hands-on annotation and mirror the screen of your mobile device on the display.

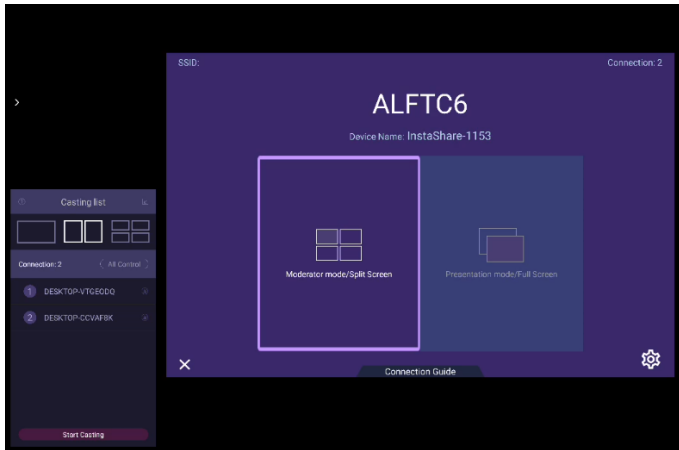

Before launching **InstaShare**, make sure your display is properly connected to Internet.



To use **InstaShare**:

1. Make sure your mobile device (such as smartphone or tablet) and the display are connected to the same network.
2. Download and install the **InstaShare** app on your mobile device.
3. Select  to launch **InstaShare** on your display.
4. Launch the **InstaShare** app on your mobile device, and then click the **InstaShare** ID name that you want to connect to or enter the pairing code.
5. Enter the connect code shown on the upper right corner of the display or you can also find the connect code in **Setting** .
6. Once the mobile device has successfully connected to the display, a confirmation message will appear on the display. Select **Allow** on the display to confirm the connection.
7. Once connected you can:
 - Mirror the display's screen on your mobile device by tapping **Screen Mirroring** on your mobile device.
 - Mirror the device's screen on the display by tapping  on your mobile device.
 - Control the display by using your mobile device as a remote control.



Once connected, any operations on the display or mobile device will also show up on your mobile device and display.

You can also select **Setting** (⚙️) in the lower right corner of the display to modify the settings for **InstaShare**, such as the **InstaShare** ID name, connect code, or mirroring confirmation message.

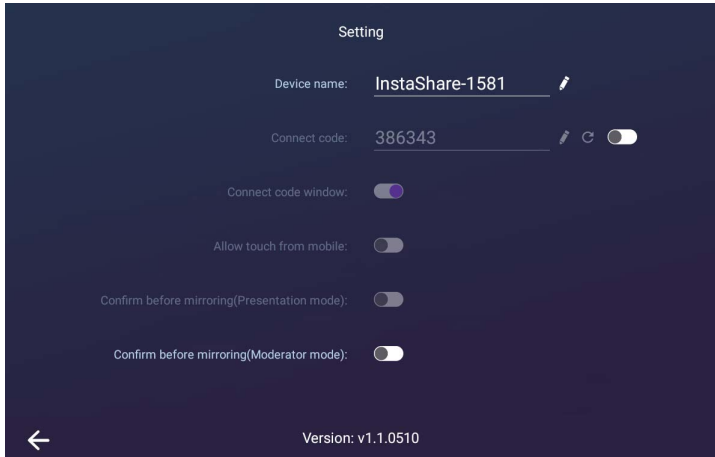

BenQ Suggests

BenQ Suggests allows you to view and download recommended apps.

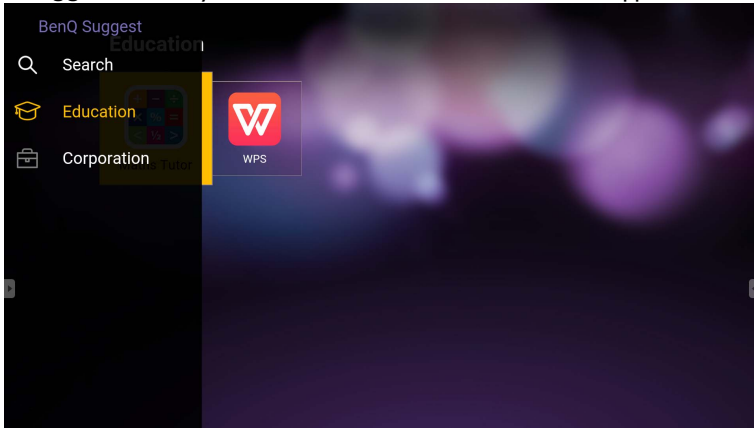

After **BenQ Suggests** is launched, you can select the category on the left panel to browse the suggested apps. Select an app from the selected category to view the basic description of the app.

Function	Description
Search (🔍)	Searches for an app.
Education (🎓)	Opens the recommended app list in the Education category.
Corporation (💼)	Opens the recommended app list in the Corporation category.
Exit (⏪)	Closes BenQ Suggests .

WPS Office

WPS Office allows you to read PDF files or edit files that are supported in Microsoft Office, PowerPoint, and Excel.

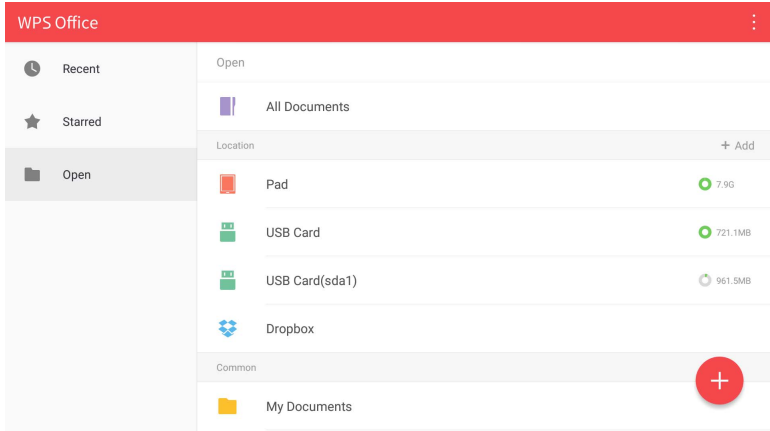

To edit a file with **WPS Office**:

Function	Description
Open	Allows you to browse and open a file.
Share	Allows you to share your files through email or other sharing applications.
Manage	Allows you to edit or manage the document.

1. Select **Open** () on the left panel to browse and open a file located in either the display's internal memory, an external storage device, or cloud storage.
2. Select the function menu on the top panel to access the file format's various functions.



The description is for a PowerPoint file, the function menus for other file formats will vary.

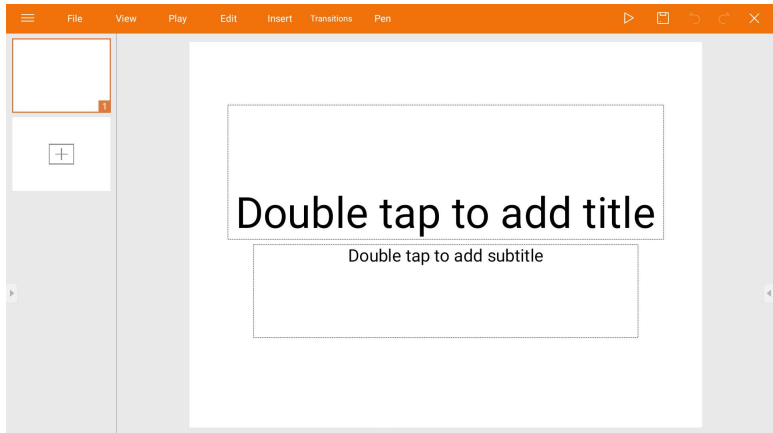

Function	Description
File	Allows you to open, save, share, print, and manage your presentations.
View	Allows you to change or edit the presentation views.
Play	Allows you to start or set up a slideshow.
Edit	Allows you to edit the content or format of the slides.
Insert	Allows you to insert tables, pictures, charts, comments, video, or audio.
Transitions	Allows you to apply or adjust the timing of a transition.
Pen	Allows you to write, draw, paint or sketch.
Play (▶)	Allows you to Select to start a slideshow.
Save As (📄)	Allows you to save the presentation file on either the display's internal memory, an external storage device, or cloud storage.
Undo (↶)	Allows you to undo an action.
Redo (↷)	Allows you to redo the last action.
Close (✕)	Allows you to close the presentation file.
Back (←)	Allows you to return to the previous page.
Next (→)	Allows you to go to the next page.
Exit (⏏)	Allows you to exit WPS Office .

Supported Office versions and file formats

Supported Office versions: 97 / 2000 / XP / 2003 / 2007 / 2010

Supported Office software formats:

Office Software	Supported File Formats
Word	wps / wpt / doc / docx / dot / dotx / txt / log / irc / c / cpp / h / asm / s / java / asp / bat / bas / prg / cmd
Excel	et / ett / xls /xlsx / xlt / xltx / csv / xlsx / xltm
PowerPoint	ppt / pptx

Media Player

Media Player allows you to view your photos or play audio or video files. **Media Player** also allows you to create and play playlists of your media files.



After **Media Player** is launched, you will see the main **Media Player** screen with the following options:

Menu	Description
Browse	Allows you to search for and play individual media files. Refer to Browse on page 45 for more information.
Play	Allows you to play your playlists. Refer to Play on page 46 for more information.
Compose	Allows you to create or edit playlists for your media files. Refer to Compose on page 47 for more information.
Settings	Allows you to set the audio or video effects for your media files. Refer to Settings on page 50 for more information.

Browse

When selecting **Browse** on the main **Media Player** screen, a message will appear allowing you to select where your files are located. Once a file is selected from the location, it will begin playing.

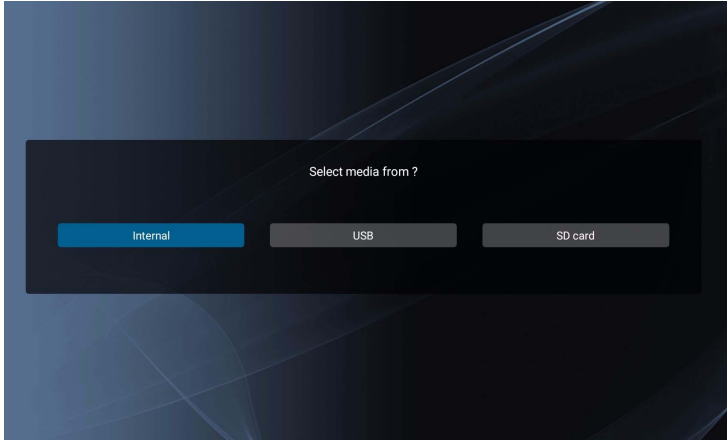

Menu	Description
Internal	Searches for files from the internal storage of the display.
USB	Searches for files from a USB flash drive connected to the display through the USB2.0 port at the left side of the display.
SD card	Searches for files from a microSD card inserted into the TF port at the left side of the display.

Play

When selecting **Play** on the main **Media Player** screen, the **PlayList** menu will appear. You can select a playlist to play.

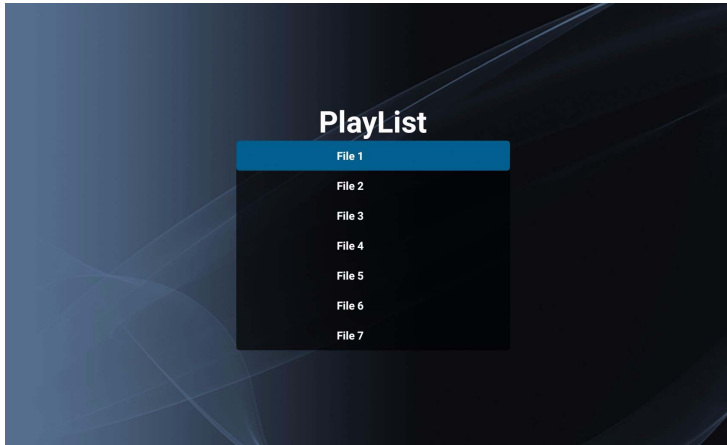

- You are allowed to create up to 7 playlists for your media files. Refer to [Compose on page 47](#) for more information.
- The **Play** menu only allows you to play playlists. If you want to play an individual media file only, use **Browse** to search for the media file and then play it directly. Refer to [Browse on page 45](#) for more information.

Compose

When selecting **Compose** on the **Media Player** screen, the **PlayList** menu will appear. You can select an empty field and start creating a playlist for your media files or edit an existing playlist.

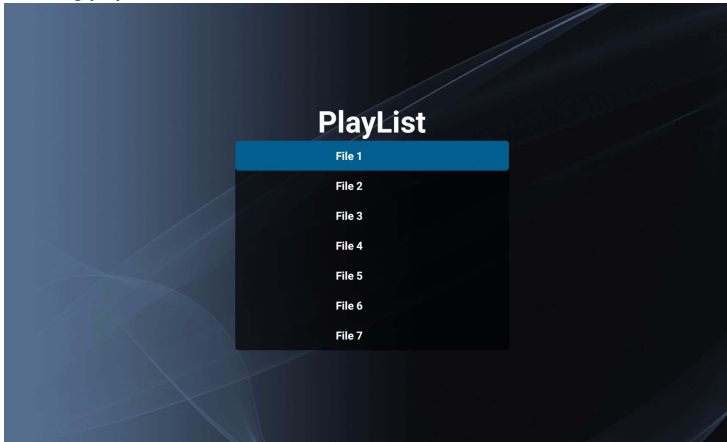

Creating/Editing a Playlist

- If you select an empty field, a message requesting you select where your files are located will appear. Select where your files are stored and start creating the playlist.

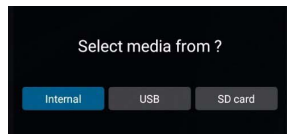

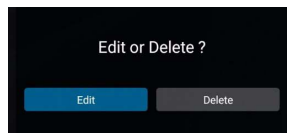

- If you select an existing playlist, a message checking whether you want to edit or remove the playlist will appear. Select **Edit** to edit the playlist.

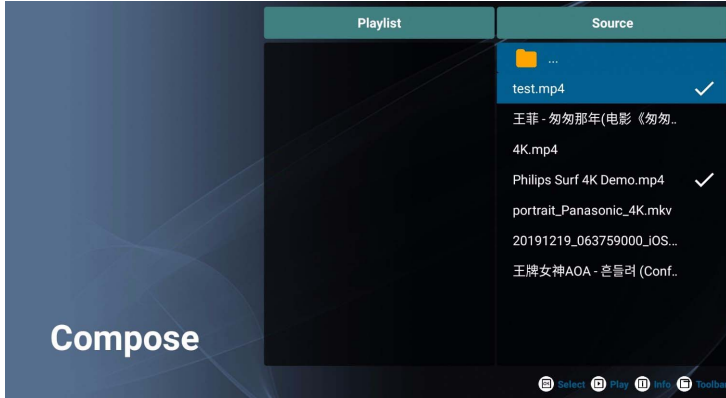

When the **Compose** screen appear, you can start creating a playlist or editing an existing playlist.



You can use the remote control to create or edit a playlist.

- To confirm the selected item, press **OK**.
- To play the file, press .
- To see the file's information, press .
- To open the toolbar, press . Refer to [Toolbar on page 48](#) for more information.

Menu	Description
Playlist	Displays the files in the playlist.
Source	Displays the files in the internal storage.

Toolbar

Compose provides various tools to help create or edit your playlists. Press  on the remote control to open the toolbar.

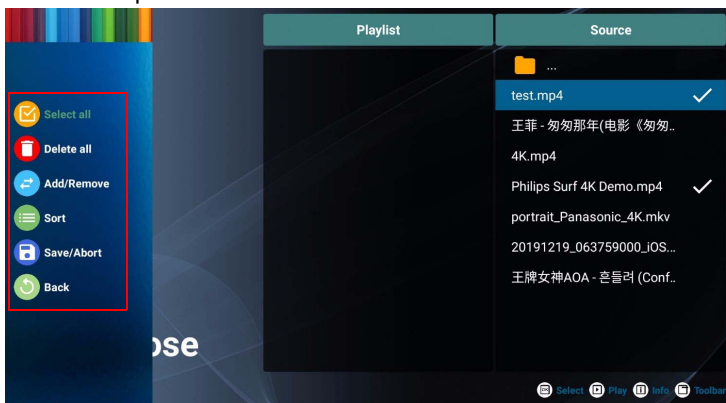

Menu	Description
Select all	Selects all files in the internal storage.

Menu	Description
Delete all	Deletes all files in the playlist.
Add/Remove	Adds a file into the playlist or removes a file from the playlist.
Sort	Prioritizes the play sequence of the files in the playlist.
Save/Abort	Saves or aborts the playlist.
Back	Closes the toolbar.

Settings

You can set the audio/video effects for the playback of your media files.

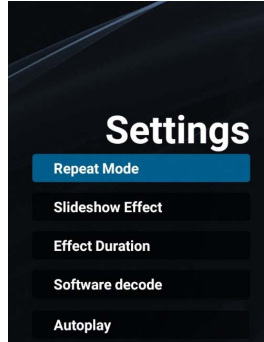

Menu	Description
Repeat Mode	Sets the repeat mode of the playlists. <ul style="list-style-type: none"> • Repeat once: Repeats the selected playlist. • Repeat all: Repeats all playlists.
Slideshow Effect	Sets the transition effects for the slideshow of your photos (Right to left / Fold / Corner / None).
Effect Duration	Sets the duration for the selected transition effect for photo slideshows (5s / 10s / 15s / 20s).
Software decode	Allows the system to decode the next video file in advance so that your video content can be played seamlessly (Enable / Disable).
Autoplay	Allows you to automatically play photos, audio files or video files stored on a USB flash drive or microSD card connected to USB2.0 port or TF port at the left side of the display.

Supported media formats

Video

Video Codec	Resolution	Bit Rate
MPEG 1/2	1080P @ 30 fps	40 Mbps
MPEG 4	1080P @ 30 fps	40 Mbps
H.263	1080P @ 30 fps	40 Mbps
H.264	4k2k @ 60 fps	135 Mbps
H.265	4k2k @ 60 fps	100 Mbps
VP8	1920 x 1080 @ 30 fps	50 Mbps

Audio

Audio Codec	Sampling Rate	Channel	Bit Rate
MPEG 1/2/2.5 Layer 3	8 KHz - 48 KHz	2	8 Kbps - 320 Kbps
MPEG 1/2 Layer 1	16 KHz - 48 KHz	2	32 Kbps - 448 Kbps
MPEG 1/2 Layer 2	16 KHz - 48 KHz	2	8 Kbps - 384 Kbps
AAC, HEAAC	8 KHz - 48 KHz	5.1	AAC - LC: 12 Kbps - 576 Kbps V1: 6 Kbps - 288 Kbps V2: 3 Kbps - 144 Kbps

Image

Image	Photo	Resolution
JPEG	base-line	1920 x 1080
	progressive	1024 x 768
PNG	non-interlace	1920 x 1080
	interlace	1920 x 1080
BMP	/	15360 x 8640

Product information

Specifications

Item		Specifications
		ST4302S/ST5502S/ST6502S/ ST7502S/ST8602S
LCD panel	Backlight	D-LED
	Panel size	ST4302S: 43" ST5502S: 55" ST6502S: 65" ST7502S: 75" ST8602S: 86"
	Pixel pitch (mm)	ST4302S: 0.245 x 0.245 ST5502S: 0.315 x 0.315 ST6502S: 0.372 x 0.372 ST7502S: 0.4296 x 0.4296 ST8602S: 0.4935 x 0.4935
	Frame Rate	60 Hz
	Native resolution (pixels)	UHD 3840 x 2160
	Active Area (mm)	ST4302S: 941.2 x 529.4 ST5502S: 1209.6 x 680.4 ST6502S: 1428.5 X 803.5 ST7502S: 1649.7 x 927.9 ST8602S: 1894.0 x 1066.0
	Brightness (cd/m ²) (typical)	400 nits
	Contrast (typical)	ST4302S: 1200:1 ST5502S: 1300:1 ST6502S: 1200:1 ST7502S: 1200:1 ST8602S: 1200:1
	Response time (ms) (typical)	ST4302S: 8 ST5502S: 9 ST6502S: 8 ST7502S: 8 ST8602S: 8
	Panel Bit (8 or 10)	10 bit (8_bits+FRC, 1.07G colors)
	Aspect Ratio	16:9

Input	Video	ST4302S, ST5502S: VGA x1, HDMI x2 (2.0), DVI x1 ST6502S, ST7502S, ST8602S: VGA x1, HDMI x3 (2.0), DVI x1
	Audio	PC Audio input x1 (3.5mm)
	USB (Type A)	x2 (2.0)
	SD card	x1
	Control	RS232 (phone jack 2.5mm, in/out)
Output	Audio	Line out x1 (3.5mm)
	OPS-Slot	x1 (ST6502S, ST7502S, ST8602S)
Audio	Audio W (Amp)	10W x2
	Internal speaker	O
Power	Supply	100 - 240 V AC, 50/60 Hz ST4302S: 1.5A ST5502S: 2.5A ST7502S: 5.5A ST7502S: 5.5A ST8602S: 6.5A
	Consumption Max.	ST4302S: 110W ST5502S: 134W ST6502S: 170 W ST7502S: 200 W ST8602S: 360 W
	Consumption Standby	0.5W
Environment	Operating Temperature	0°C ~ 40°C
	Operating Humidity	10% ~ 80% RH Non-Condensing
	Storage Temperature	-20°C ~ 60°C
	Storage Humidity	10% ~ 80% RH Non-Condensing
	Display Orientation	Landscape Portrait (ST4302S & ST5502S only)

Mechanical	Weight (without packing / with packing) (kg)	ST4302S: 10.7/14.3 ST5502S: 16.6/22.0 ST6502S: 29.0/37.4 ST7502S: 35.9/46.1 ST8602S: 50.0/64.3
	Dimensions (W x H x D) (mm)	ST4302S: 973.0 x 561.2 x 63.5 ST5502S: 1241.8 x 712.6 x 63.5 ST6502S: 1462.3 x 837.3 x 68.9 ST7502S: 1683.5 x 961.7 x 69.5 ST8602S: 1929.1 x 1100.0 x 69.5
	Bezel Dimension - T/B/L/R (mm)	ST4302S: 13.9/13.9/13.9/13.9 ST5502S: 13.9/13.9/13.9/13.9 ST6502S: 14.9/14.9/14.9/14.9 ST7502S: 14.9/14.9/14.9/14.9 ST8602S: 15.5/15.5/15.5/15.5
Feature	Image setting	○
	Sharpness enhancement	○
	10-bit color processing	○
	Source / volume control	○
	HDMI-HDCP	2.2
	Internal Temperature Sensor	○
	CEC Control	○
	FW Update	USB/OTA
RTC Function	○	



Specifications and functions are subject to change without notice.

Item		ST4302S/ST5502S/ST6502S/ ST7502S/ST8602S
System	System Memory	3 GB
	Storage	16 GB
	OS	Android 8.0



- OS: This Android 8.0 operating system is not standard Android, so access to **Google Play™** is not available. APK cannot be installed in the default location. Without management permission, installing function will not work. There is no guarantee that the self-installed APK can function normally.
- Storage: Content storage may vary by the product supplied for your region. Pre-installed system and apps may take up some space.

Dimensions

ST4302S

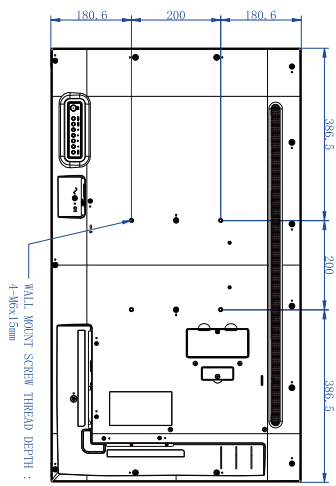
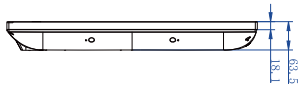
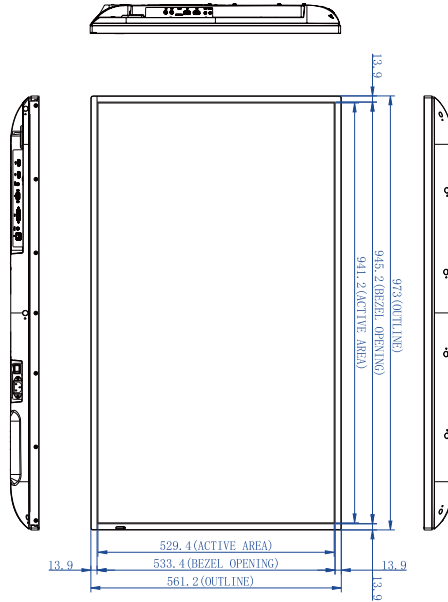

Unit: mm

ST5502S

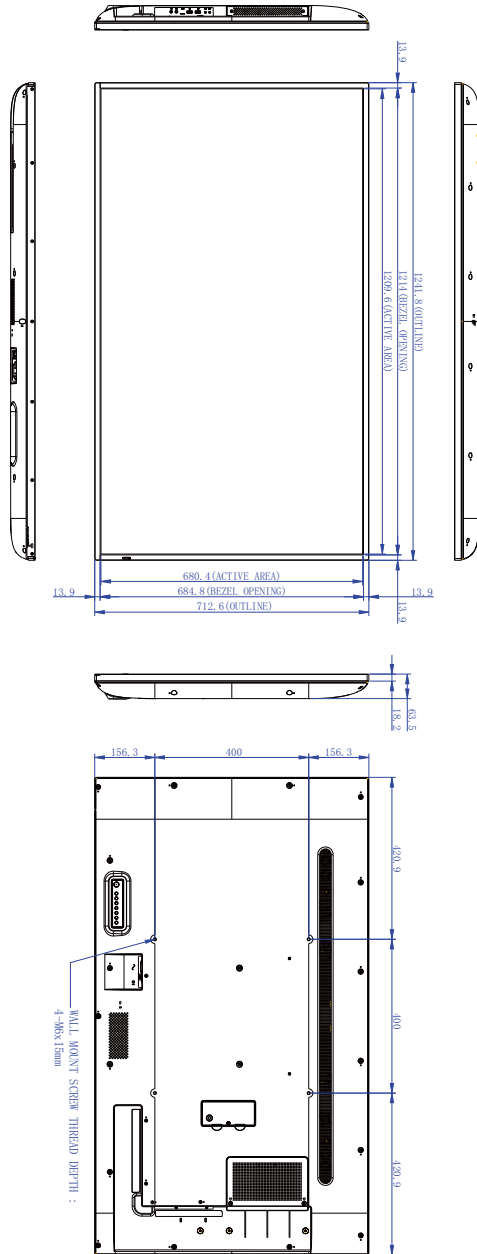

Unit: mm

ST6502S

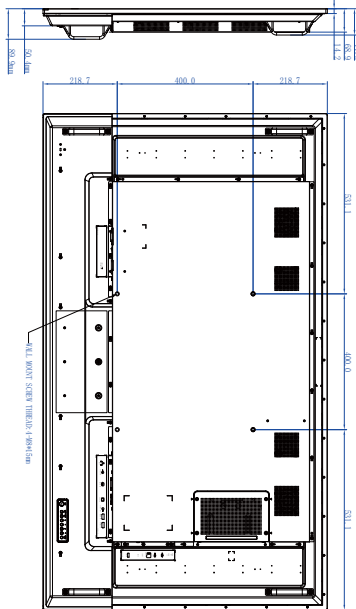
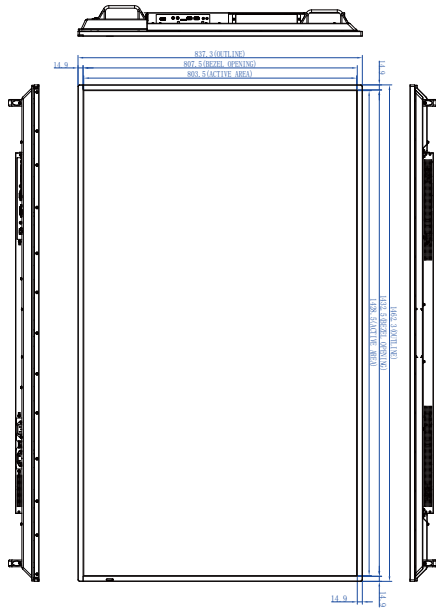

Unit: mm

ST7502S

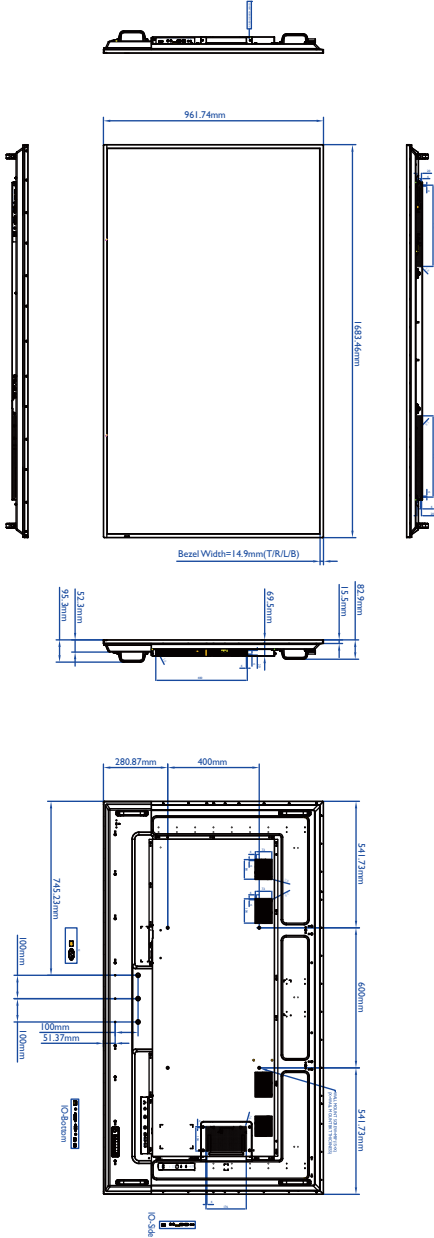

Unit: mm

ST8602S

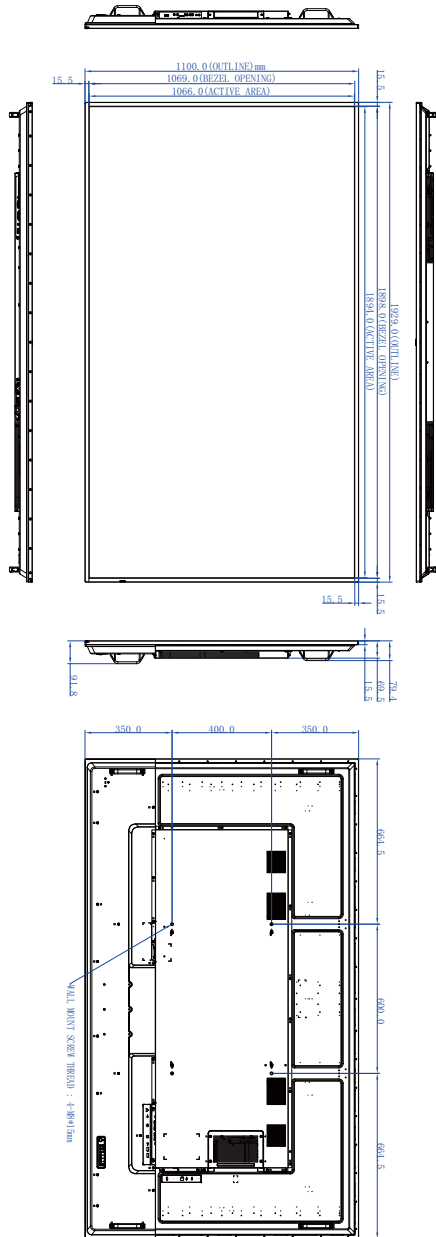

Unit: mm

Supported input signal resolution

Resolution PC Timing (PC device)	Input source	
	HDMI 1.4/2.0	VGA/DVI
640 x 480 @ 60Hz	○	○
640 x 480 @ 75Hz	○	○
720 x 400 @ 70Hz	○	○
800 x 600 @ 60Hz	○	○
832 x 624 @ 75Hz	○	○
1024 x 768 @ 60Hz	○	○
1280 x 720 @ 60Hz	○	○
1280 x 1024 @ 60Hz	○	○
1440 x 900 @ 60Hz	○	○
1680 x 1050 @ 60Hz	○	○
1920 x 1080 @ 60Hz	○	○
3840 x 2160 @ 30Hz	○	
3840 x 2160 @ 60Hz	○ (HDMI 2.0 only)	

Resolution Video Timing (non-PC device)	Input source (HDMI 1.4 / 2.0)
640 x 480 P 59.94 @ 60Hz 4:3	○
720 x 480 P 59.94 @ 60Hz 4:3	○
720 x 480 P 59.94 @ 60Hz 16:9	○
720 (1440) x 480 I 59.94 @ 60Hz 4:3	○
720 (1440) x 480 I 59.94 @ 60Hz 16:9	○
720 x 576 P @ 50Hz 4:3	○
720 x 576 P @ 50Hz 16:9	○
720 (1440) x 576 I @ 50Hz 4:3	○
720 (1440) x 576 I @ 50Hz 16:9	○
1280 x 720 P 59.94 @ 60Hz 16:9	○
1280 x 720 P @ 50Hz 16:9	○
1280 x 720 @ 60Hz	○ (HDMI 1.4 only)

Resolution Video Timing (non-PC device)	Input source (HDMI 1.4 / 2.0)
1920 x 1080 P 59.94 @ 60Hz 16:9	○
1920 x 1080 I 59.94 @ 60Hz 16:9	○
1920 x 1080 P @ 50Hz 16:9	○
1920 x 1080 I @ 50Hz 16:9	○
1920 x 1080 @ 60Hz	○ (HDMI 2.0 only)
3840 x 2160 P 59.94 @ 60Hz	○ (HDMI 2.0 only)
3840 x 2160 P 29.97 @ 30Hz	○ (HDMI 2.0 only)
3840 x 2160 P 23.98 @ 24Hz	○ (HDMI 2.0 only)
3840 x 2160 P @ 50Hz	○ (HDMI 2.0 only)
3840 x 2160 P @ 25Hz	○ (HDMI 2.0 only)
3840 x 2160 @ 30Hz	○ (HDMI 2.0 only)



- ○: supported
- Blank: not supported

Troubleshooting

Problem	Solution
No video / image	<ul style="list-style-type: none"> • Is the display turned on? Check the power status indicator of the display. • Is the signal source device turned on? Turn on the device and try again. • Are there any loose cable connections? Make sure that all cables are connected firmly. • Have you chosen an unsupported output resolution on the computer? Refer to Supported input signal resolution on page 60 to select a supported resolution and try again.
No sound	<ul style="list-style-type: none"> • Have you turned on the mute function on the display or the input source device? Turn off the mute function or increase the audio volume level and try again. • Are there any loose cable connections? Make sure that all cables are connected firmly.
The input content looks strange.	<ul style="list-style-type: none"> • Have you chosen an unsupported output resolution on the computer? Refer to Supported input signal resolution on page 60 to select a supported resolution and try again. • Use the Auto adjust function to let the display automatically optimize the display of computer image or manually adjust the H. Position, V position, Clock, and Clock phase for the input image. Refer to Screen on page 28 for more information.
The control panel buttons do not work.	<p>Have you locked the control panel buttons? Unlock the buttons and try again.</p>
The remote control does not work.	<ul style="list-style-type: none"> • Have you locked the remote control function? Unlock the function and try again. • Check for incorrect battery orientation. • Check for dead batteries. • Check your distance and angle from the display. • Check whether remote control is properly being pointed at the display's remote control sensor window. • Check for any obstacle between the remote control and the remote control sensor window. • Check that the remote control sensor window is not under strong fluorescent lighting, or in direct sunlight. • Check for any devices (computer or personal digital assistant, PDA) nearby that transmit infrared signals which may cause interference to signal transmission between the remote control and the display. Turn off the infrared function of these devices.